

Naht
Suture
Suture
Sutura

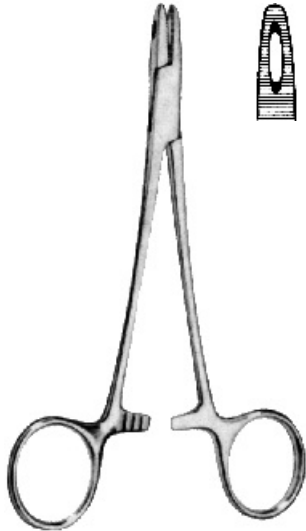



Collier

HB 2301 12,5 cm/5"

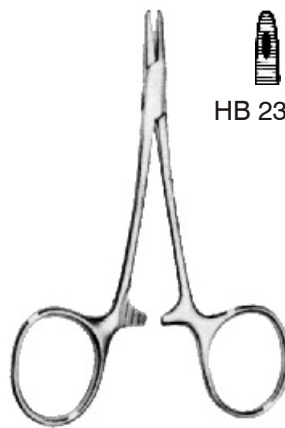

Derf

12,5 cm/5"

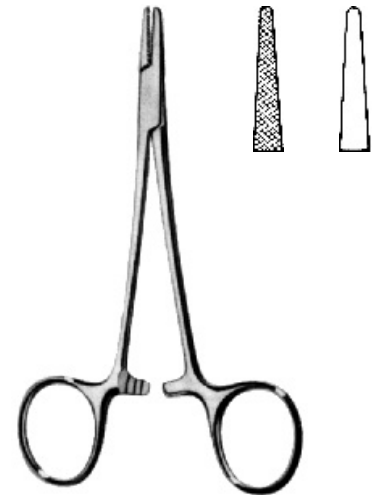

Halsey

HB 2310 13,0 cm/5" HB 2311
gerieft glatt
serrated smooth
striée lisse
estriada lisa



Webster

HB 2312 13,0 cm/5"
glatt
smooth
lisse
lisa

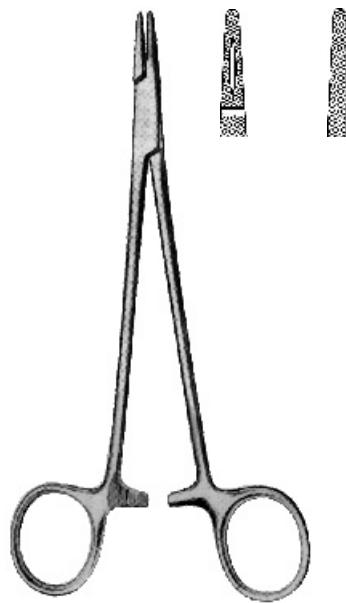

Crile-Wood

HB 2314 15,0 cm/6"
mit Rille
with groove
avec cannelure
con ranura

Crile-Wood

HB 2315
ohne Rille
without groove
sans cannelure
sin ranura



Brown

HB 2318 13,0 cm/5"
HB 2319 18,0 cm/7"



Sarot

HB 2322 18,0 cm/7¼"
 HB 2324 26,0 cm/10¼"



M.G.H.

HB 2329 17,0 cm/6¾"

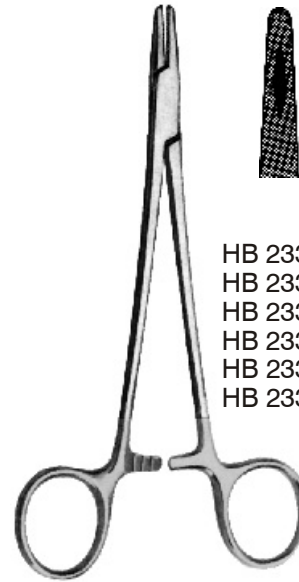

Mayo-Hegar

| | | |
|---------|--------------|---------|
| HB 2330 | 14,0 cm/5½" | HB 2341 |
| HB 2331 | 16,0 cm/6¼" | HB 2342 |
| HB 2332 | 18,0 cm/7¼" | HB 2343 |
| HB 2333 | 20,0 cm/8" | HB 2344 |
| HB 2334 | 24,0 cm/9½" | HB 2345 |
| HB 2335 | 26,0 cm/10¼" | |

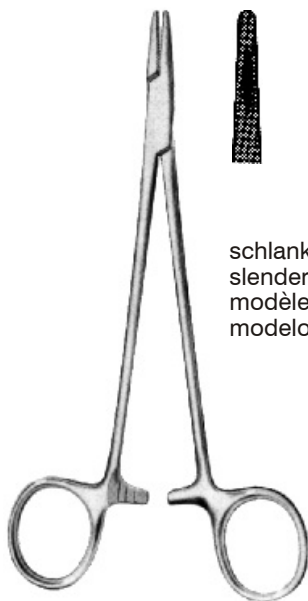

Mayo-Hegar

HB 2351 16,0 cm/6¼"
 HB 2352 18,0 cm/7"
 HB 2353 20,0 cm/8"

schlankes Modell
 slender pattern
 modèle gracile
 modelo delgado

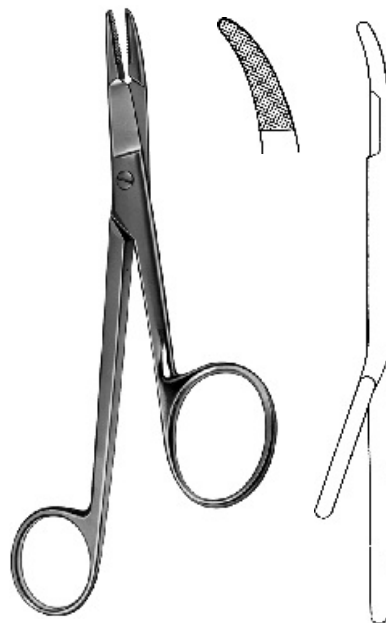

Gillies

HB 2354 16,0 cm/6¼"



Hegar-Baumgartner

HB 2355 14,0 cm/5½"



für sehr feine Nadeln
for fine needles
pour des aiguilles très fines
para agujas finas

Baby-Olsen-Hegar
11,5 cm/4½"

| | |
|------------|------------|
| HB 2356-01 | HB 2356-02 |
| gerieft | glatt |
| serrated | smooth |
| striée | lisse |
| estriada | lisa |



Olsen-Hegar

HB 2357 14,0 cm/5½"



Olsen-Hegar

HB 2358 16,0 cm/6¼"

kräftige Ausführung
heavy pattern
modèle robuste
de fuerte construcción



Olsen-Hegar

HB 2257N 14,0 cm/5½"



Olsen-Hegar

HB 2258N 17,0 cm/6¼"



Olsen-Hegar

HB 2359 18,0 cm/7"

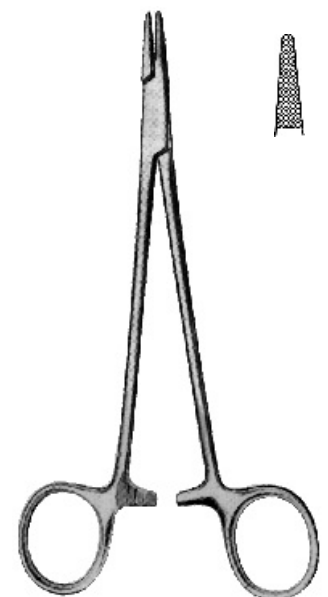

Crile-Wood

HB 2360 15,0 cm/6"
HB 2361 18,0 cm/7"
HB 2362 20,0 cm/8"
HB 2363 23,0 cm/9"

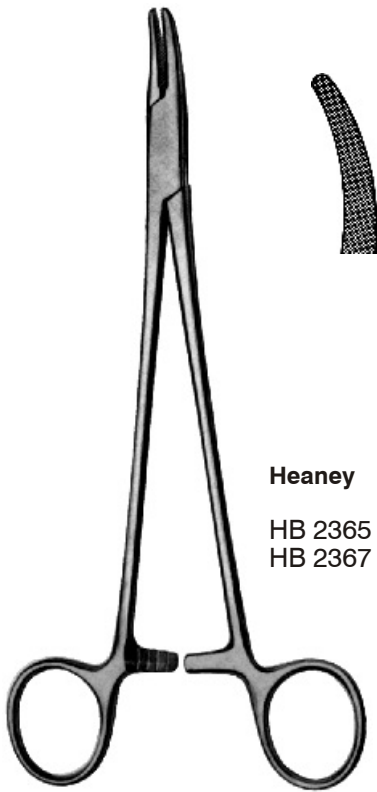

Heaney

HB 2365 21,0 cm/8¼"
 HB 2367 26,0 cm/10¼"

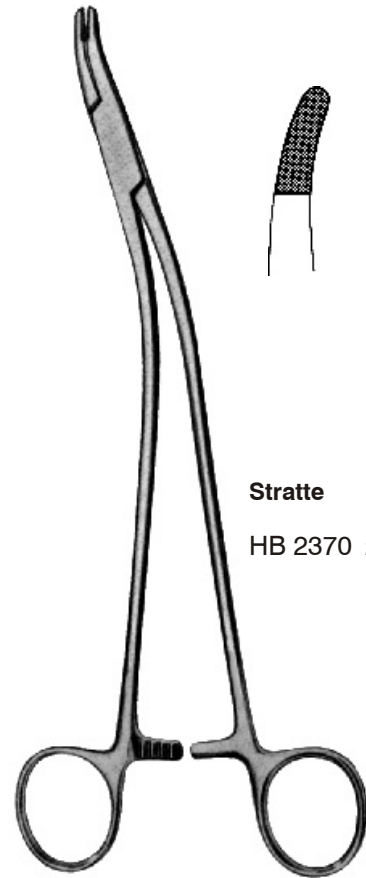

Stratte

HB 2370 23,0 cm/9"

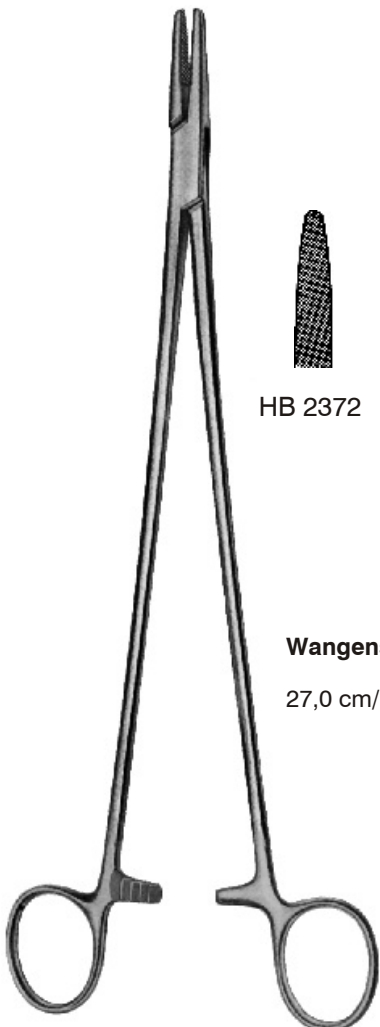

Wangenstein

27,0 cm/10½"

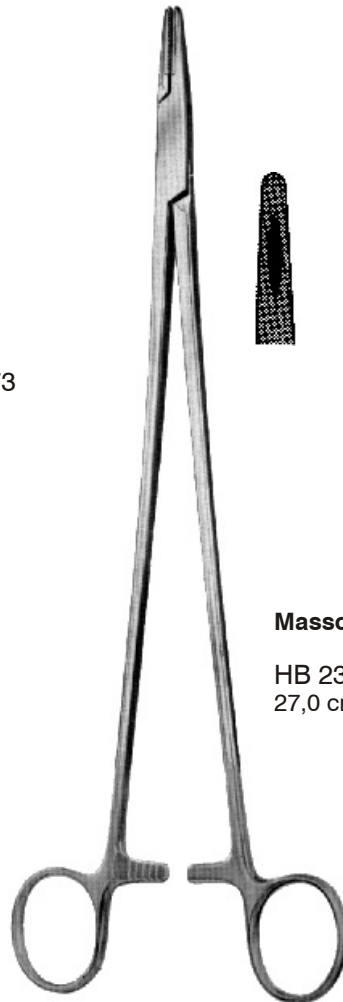

Masson

HB 2375
 27,0 cm/10½"

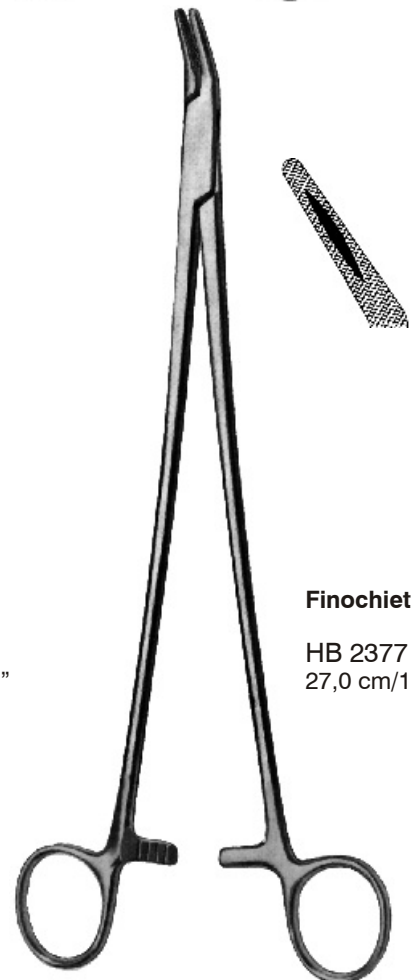

Finochietto

HB 2377
 27,0 cm/10½"



Crile
 HB 2382 15,0 cm/6"

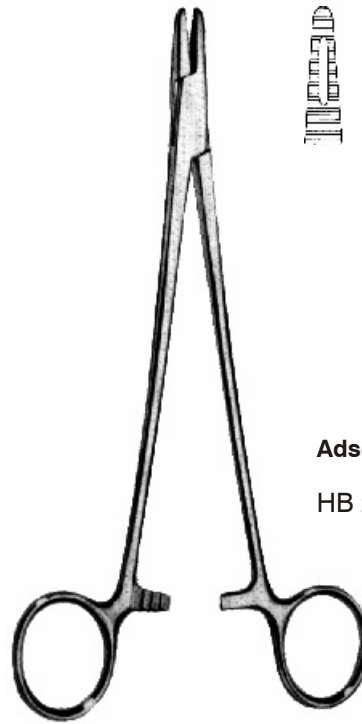

Adson
 HB 2384 18,0 cm/7"

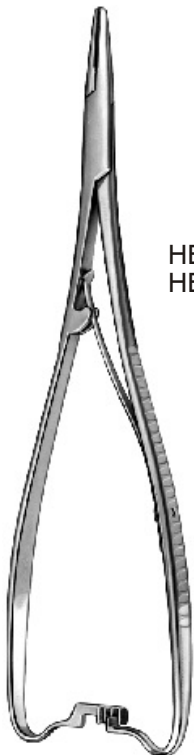

HB 2385 17,0 cm/6½"
 HB 2386 20,0 cm/8" HB 2390
 HB 2391

Mathieu



HB 2387 14,0 cm/2½"
 HB 2388 17,0 cm/6½"
 HB 2389 20,0 cm/8" HB 2392
 HB 2393
 HB 2394



HB 2397 14,0 cm/5½"
 HB 2398 17,0 cm/6¾"
 schlankes Maul
 slender jaw
 mors étroit
 boca fina

Mathieu

HB 2388K 17,0 cm/6½"
 HB 2389K 20,0 cm/8"
 kräftige Ausführung
 heavy pattern
 modèle robuste
 de fuerte construcción

Augennadelhalter
Eye Needle Holders
Porte-aiguilles pour les yeux
Porta-agujas para ojos



mit Sperre, with ratchet
avec crémaillère, con cremallera



HB 2405-14 14,0 cm/5½"
 HB 2405-18 18,0 cm/7"
 HB 2405-21 21,0 cm/8¼"
 gerade
 straight
 droite
 recta



HB 2406-14
 HB 2406-18
 HB 2406-21
 gebogen
 curved
 courbe
 curva



HB 2419-14 14,0 cm/5½"
 gerade
 straight
 droite
 recta



HB 2420-14
 gebogen
 curved
 courbe
 curva



Castroviejo

ohne Sperre, without ratchet
sans crémaillère, sin cremallera



HB 2407-14 14,0 cm/5½"
 gerade
 straight
 droite
 recta



HB 2408-14
 gebogen
 curved
 courbe
 curva

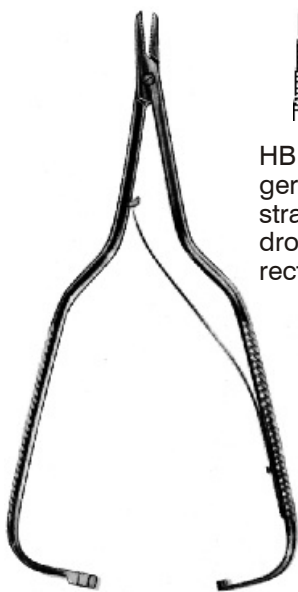

Arruga

16,0 cm/6¼"



HB 2401
 gerade
 straight
 droite
 recta



HB 2402
 gebogen
 curved
 courbe
 curva



Kalt

HB 2410 14,0 cm/5½"



Barraquer

HB 2412 13,5 cm/5"
 HB 2417 18,0 cm/7"
 gerade
 straight
 droite
 recta







HB 2413
 HB 2418
 gebogen
 curved
 courbe
 curva

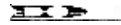

Gewöhnliches Öhr
 Regular eye
 Chas régulier
 Ojo ordinario



Federöhr
 Spring eye
 Chas à ressort
 Ojo de resorte

| | | | | |
|---|-------------|-------------|-------------|-------------|
|  | gerade | straight | droite | recta |
|  | halbgebogen | half curved | 1/2 courbée | 1/2 curva |
|  | 3/8 Kreis | 3/8 circle | 3/8 cercle | 3/8 círculo |
|  | 1/2 Kreis | 1/2 circle | 1/2 cercle | 1/2 círculo |



Nadeln mit dreikantiger Schneide
 Triangular point
 Pointe triangulaire
 Punta triangular



Runde Nadeln
 Round point
 Pointe ronde
 Punta redonda

| Bestell-Nr. + Order-No. + Ref. No. + Ref. No. + | Größen sizes mesures tamaños |
|--|---------------------------------------|
| -30 | 000 |
| -20 | 00 |
| -00 | 0 |
| -01 | 1 |
| -02 | 2 |
| -03 | 3 |
| -04 | 4 |
| -05 | 5 |
| -06 | 6 |
| -07 | 7 |
| -08 | 8 |
| -09 | 9 |
| -10 | 10 |
| -11 | 11 |
| -12 | 12 |
| -13 | 13 |
| -14 | 14 |
| -15 | 15 |
| -16 | 16 |

Verpackungsformen: Päckchen à 12 Stück
 Packaging: packets of 12 pieces
 Formes d'emballage: paquets de 12 pièces
 Formas de embalaje: paquetes de 12 unidades

Haut- und Muskelnadeln
Muscular and Skin Suture
Sutures musculaires et cutanées
Suturas musculares y cutáneas

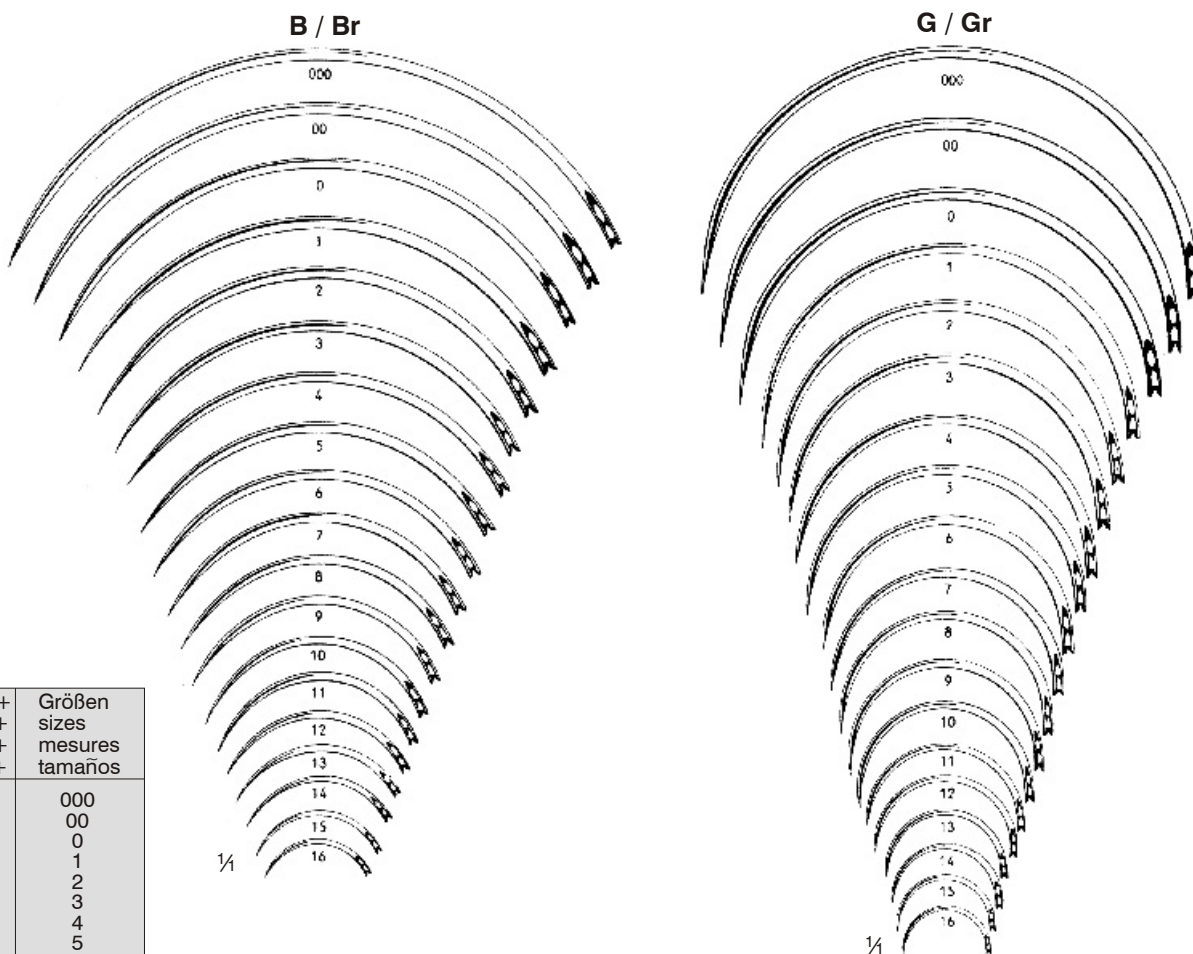

| Bestell-Nr. + Order-No. + Ref. No. + Ref. No. + | Größen sizes mesures tamaños |
|--|---------------------------------------|
| -30 | 000 |
| -20 | 00 |
| -00 | 0 |
| -01 | 1 |
| -02 | 2 |
| -03 | 3 |
| -04 | 4 |
| -05 | 5 |
| -06 | 6 |
| -07 | 7 |
| -08 | 8 |
| -09 | 9 |
| -10 | 10 |
| -11 | 11 |
| -12 | 12 |
| -13 | 13 |
| -14 | 14 |
| -15 | 15 |
| -16 | 16 |

| Bestell-Nr. Order-No. Ref. No. Ref. No. | | Öhr Eye Chas Ojo | Größen Sizes Mesures Tamaños | Profil Profile Profil Perfil | Biegung Curvature Courbure Curvatura |
|--|----|---------------------------|---------------------------------------|---------------------------------------|--|
| HB 2440-30 - HB 2440-16 | B | | 000 - 16 | ▲ | 3/8 Kreis; 3/8 circle; 3/8 cercle; 3/8 círculo |
| HB 2441-30 - HB 2441-16 | B | | 000 - 16 | ▲ | 3/8 Kreis; 3/8 circle; 3/8 cercle; 3/8 círculo |
| HB 2442-30 - HB 2442-16 | Br | | 000 - 16 | ● | 3/8 Kreis; 3/8 circle; 3/8 cercle; 3/8 círculo |
| HB 2443-30 - HB 2443-16 | Br | | 000 - 16 | ● | 3/8 Kreis; 3/8 circle; 3/8 cercle; 3/8 círculo |
| HB 2446-30 - HB 2446-16 | G | | 000 - 16 | ▲ | 1/2 Kreis; 1/2 circle; 1/2 cercle; 1/2 círculo |
| HB 2447-30 - HB 2447-16 | G | | 000 - 16 | ▲ | 1/2 Kreis; 1/2 circle; 1/2 cercle; 1/2 círculo |
| HB 2448-30 - HB 2448-16 | Gr | | 000 - 16 | ● | 1/2 Kreis; 1/2 circle; 1/2 cercle; 1/2 círculo |
| HB 2449-30 - HB 2449-16 | Gr | | 000 - 16 | ● | 1/2 Kreis; 1/2 circle; 1/2 cercle; 1/2 círculo |

Ga / Gar

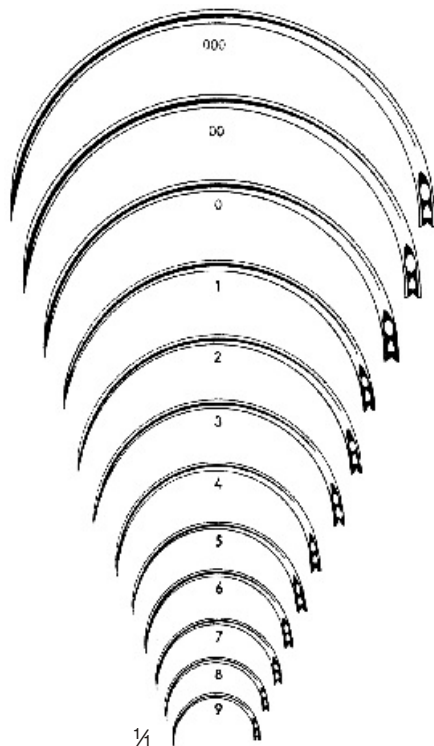

Keith

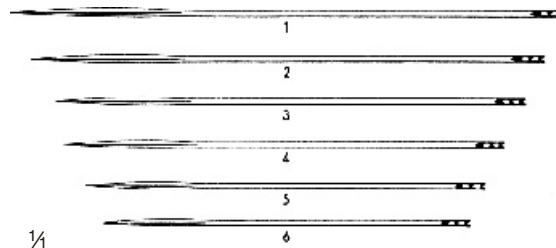

| Bestell-Nr. + Order-No. + Ref. No. + Ref. No. + | Größen sizes mesures tamaños |
|--|---------------------------------------|
| -30 | 000 |
| -20 | 00 |
| -00 | 0 |
| -01 | 1 |
| -02 | 2 |
| -03 | 3 |
| -04 | 4 |
| -05 | 5 |
| -06 | 6 |
| -07 | 7 |
| -08 | 8 |
| -09 | 9 |
| -10 | 10 |
| -11 | 11 |
| -12 | 12 |
| -13 | 13 |
| -14 | 14 |
| -15 | 15 |
| -16 | 16 |

| Bestell-Nr. Order-No. Ref. No. Ref. No. | | Öhr Eye Chas Ojo | Größen Sizes Mesures Tamaños | Profil Profile Profil Perfil | Biegung Curvature Courbure Curvatura |
|--|-------|---------------------------|---------------------------------------|---------------------------------------|---|
| HB 2451-30 - HB 2451-09 | Ga | | 000 - 9 | ▲ | ½ Kreis; ½ circle; ½ cercle; ½ círculo |
| HB 2452-30 - HB 2452-09 | Ga | | 000 - 9 | ▲ | ½ Kreis; ½ circle; ½ cercle; ½ círculo |
| HB 2453-30 - HB 2453-09 | Gar | | 000 - 9 | ● | ½ Kreis; ½ circle; ½ cercle; ½ círculo |
| HB 2454-30 - HB 2454-09 | Gar | | 000 - 9 | ● | ½ Kreis; ½ circle; ½ cercle; ½ círculo |
| HB 2457-01 - HB 2457-06 | Keith | | 1 - 6 | ▲ | gerade, straight, droite, recta |
| HB 2458-01 - HB 2458-06 | Keith | | 1 - 6 | ▲ | gerade, straight, droite, recta |
| HB 2459-01 - HB 2459-06 | Keith | | 1 - 6 | ● | gerade, straight, droite, recta |
| HB 2460-01 - HB 2460-06 | Keith | | 1 - 6 | ● | gerade, straight, droite, recta |

Haut- und Muskelnadeln
Muscular and Skin Suture
Sutures musculaires et cutanées
Suturas musculares y cutáneas

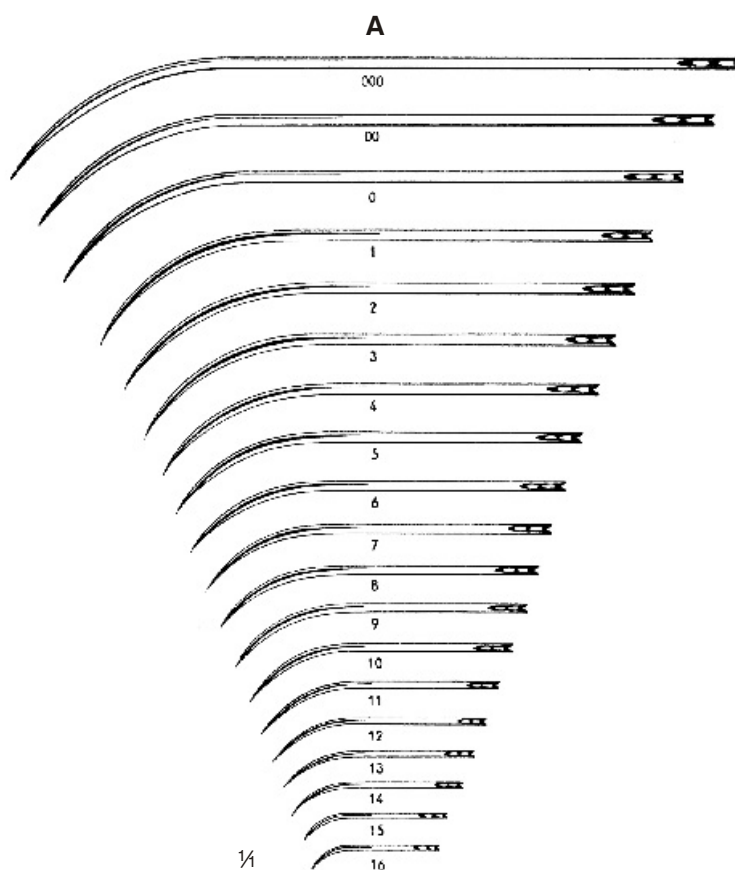
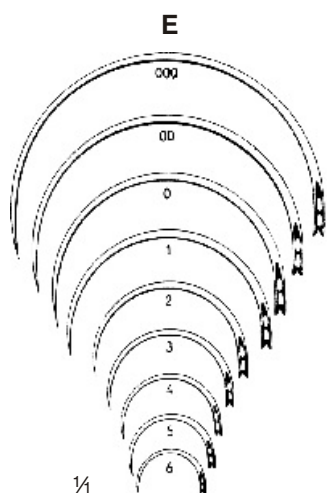

| Bestell-Nr. + Order-No. + Ref. No. + Ref. No. + | Größen sizes mesures tamaños |
|--|---------------------------------------|
| -30 | 000 |
| -20 | 00 |
| -00 | 0 |
| -01 | 1 |
| -02 | 2 |
| -03 | 3 |
| -04 | 4 |
| -05 | 5 |
| -06 | 6 |
| -07 | 7 |
| -08 | 8 |
| -09 | 9 |
| -10 | 10 |
| -11 | 11 |
| -12 | 12 |
| -13 | 13 |
| -14 | 14 |
| -15 | 15 |
| -16 | 16 |

| Bestell-Nr. Order-No. Ref. No. Ref. No. | | Öhr Eye Chas Ojo | Größen Sizes Mesures Tamaños | Profil Profile Profil Perfil | Biegung Curvature Courbure Curvatura |
|--|---|---------------------------|---------------------------------------|---------------------------------------|--|
| HB 2463-30 - HB 2463-06 | E | | 000 - 6 | ● | 1/2 Kreis; 1/2 circle; 1/2 cercle; 1/2 círculo |
| HB 2464-30 - HB 2464-06 | E | | 000 - 6 | ● | 1/2 Kreis; 1/2 circle; 1/2 cercle; 1/2 círculo |

| | | | | | |
|-------------------------|---|--|----------|---|---|
| HB 2466-30 - HB 2466-16 | A | | 000 - 16 | ▲ | halb-gebogen, half-curved, 1/2 courbée, 1/2 curva |
| HB 2467-30 - HB 2467-16 | A | | 000 - 16 | ▲ | halb-gebogen, half-curved, 1/2 courbée, 1/2 curva |

Darmnadeln
Intestinal Needles
Aguilles intestinales
Agujas intestinales

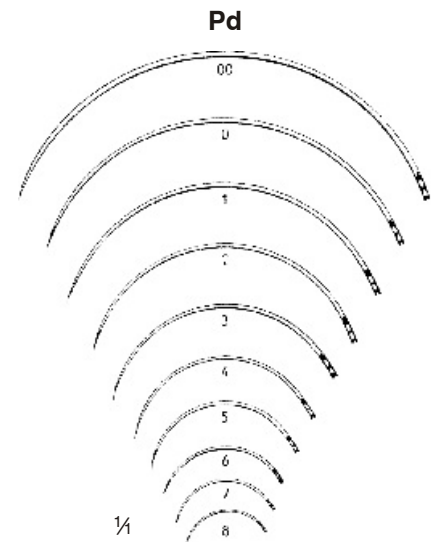
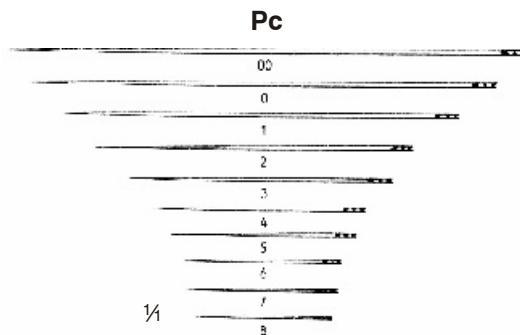
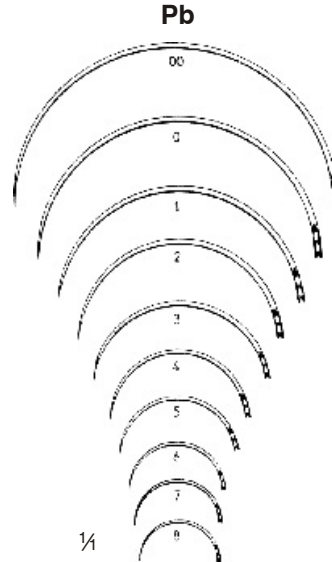
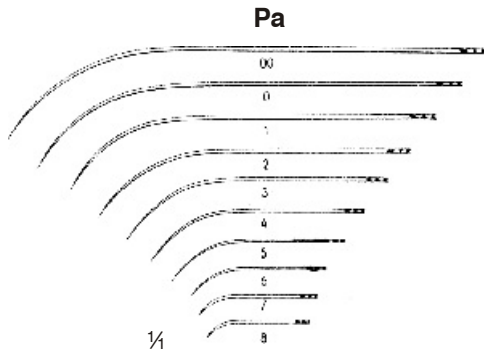

| Bestell-Nr. + Order-No. + Ref. No. + Ref. No. + | Größen sizes mesures tamaños |
|--|---------------------------------------|
| -30 | 000 |
| -20 | 00 |
| -00 | 0 |
| -01 | 1 |
| -02 | 2 |
| -03 | 3 |
| -04 | 4 |
| -05 | 5 |
| -06 | 6 |
| -07 | 7 |
| -08 | 8 |
| -09 | 9 |
| -10 | 10 |
| -11 | 11 |
| -12 | 12 |
| -13 | 13 |
| -14 | 14 |
| -15 | 15 |
| -16 | 16 |

| Bestell-Nr. Order-No. Ref. No. Ref. No. | | Öhr Eye Chas Ojo | Größen Sizes Mesures Tamaños | Profil Profile Profil Perfil | Biegung Curvature Courbure Curvatura |
|--|----|---------------------------|---------------------------------------|---------------------------------------|---|
| HB 2470-20 - HB 2470-08 | Pa | | 00 - 8 | ● | halb-gebogen, half-curved, 1/2 courbée, 1/2 curva |
| HB 2471-20 - HB 2471-08 | Pa | | 00 - 8 | ● | halb-gebogen, half-curved, 1/2 courbée, 1/2 curva |
| HB 2472-20 - HB 2472-08 | Pb | | 00 - 8 | ● | 1/2 Kreis; 1/2 circle; 1/2 cercle; 1/2 círculo |
| HB 2473-20 - HB 2473-08 | Pb | | 00 - 8 | ● | 1/2 Kreis; 1/2 circle; 1/2 cercle; 1/2 círculo |
| HB 2474-20 - HB 2474-08 | Pc | | 00 - 8 | ● | gerade, straight, droite, recta |
| HB 2475-20 - HB 2475-08 | Pc | | 00 - 8 | ● | gerade, straight, droite, recta |
| HB 2476-20 - HB 2476-08 | Pd | | 00 - 8 | ● | 3/8 Kreis; 3/8 circle; 3/8 cercle; 3/8 círculo |
| HB 2477-20 - HB 2477-08 | Pd | | 00 - 8 | ● | 3/8 Kreis; 3/8 circle; 3/8 cercle; 3/8 círculo |

Gefäß- und Augennadeln
Vein and Eye Needles
Aiguilles veineuses et ophtalmiques
Agujas para venas y oftalmológicas

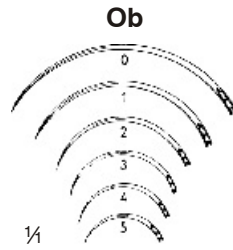
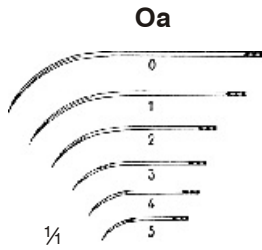

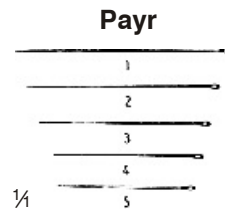
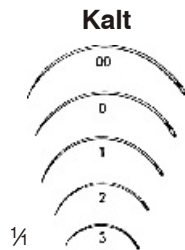

| Bestell-Nr. + Order-No. + Ref. No. + Ref. No. + | Größen sizes mesures tamaños |
|--|---------------------------------------|
| -30 | 000 |
| -20 | 00 |
| -00 | 0 |
| -01 | 1 |
| -02 | 2 |
| -03 | 3 |
| -04 | 4 |
| -05 | 5 |
| -06 | 6 |
| -07 | 7 |
| -08 | 8 |
| -09 | 9 |
| -10 | 10 |
| -11 | 11 |
| -12 | 12 |
| -13 | 13 |
| -14 | 14 |
| -15 | 15 |
| -16 | 16 |

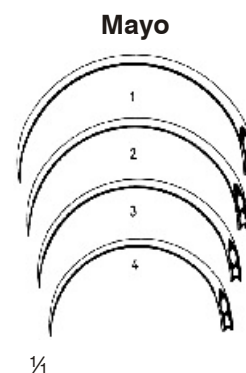
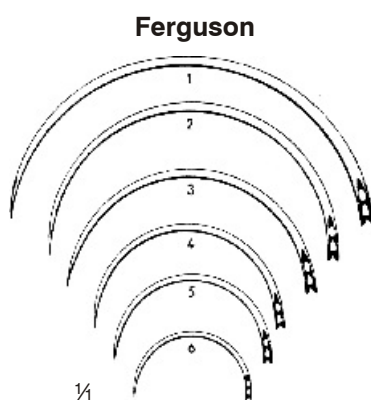

| Bestell-Nr. Order-No. Ref. No. Ref. No. | | Öhr Eye Chas Ojo | Größen Sizes Mesures Tamaños | Profil Profile Profil Perfil | Biegung Curvature Courbure Curvatura |
|--|------|---------------------------|---------------------------------------|---------------------------------------|---|
| HB 2480-00 - HB 2480-05 | Oa | | 0 - 5 | ▲ | halb-gebogen, half-curved, 1/2 courbée, 1/2 curva |
| HB 2481-00 - HB 2481-05 | Oa | | 0 - 5 | ▲ | halb-gebogen, half-curved, 1/2 courbée, 1/2 curva |
| HB 2482-00 - HB 2482-05 | Ob | | 0 - 5 | ▲ | 3/8 Kreis; 3/8 circle; 3/8 cercle; 3/8 círculo |
| HB 2483-00 - HB 2483-05 | Ob | | 0 - 5 | ▲ | 3/8 Kreis; 3/8 circle; 3/8 cercle; 3/8 círculo |
| HB 2484-00 - HB 2484-05 | Og | | 0 - 5 | ▲ | 1/2 Kreis; 1/2 circle; 1/2 cercle; 1/2 círculo |
| HB 2485-00 - HB 2485-05 | Og | | 0 - 5 | ▲ | 1/2 Kreis; 1/2 circle; 1/2 cercle; 1/2 círculo |
| HB 2486-20 - HB 2486-03 | Kalt | | 00-3 | ● | 3/8 Kreis; 3/8 circle; 3/8 cercle; 3/8 círculo |
| HB 2487-01 - HB 2487-05 | Payr | | 1 - 5 | ● | gerade, straight, droite, recta |
| HB 2488-20 - HB 2488-03 | Payr | | 00 - 3 | ● | 1/2 Kreis; 1/2 circle; 1/2 cercle; 1/2 círculo |

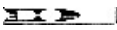

| Bestell-Nr. + Order-No. + Ref. No. + Ref. No. + | Größen sizes mesures tamaños |
|--|---------------------------------------|
| -30 | 000 |
| -20 | 00 |
| -00 | 0 |
| -01 | 1 |
| -02 | 2 |
| -03 | 3 |
| -04 | 4 |
| -05 | 5 |
| -06 | 6 |
| -07 | 7 |
| -08 | 8 |
| -09 | 9 |
| -10 | 10 |
| -11 | 11 |
| -12 | 12 |
| -13 | 13 |
| -14 | 14 |
| -15 | 15 |
| -16 | 16 |

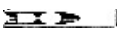
| Bestell-Nr. Order-No. Ref. No. Ref. No. | | Öhr Eye Chas Ojo | Größen Sizes Mesures Tamaños | Profil Profile Profil Perfil | Biegung Curvature Courbure Curvatura |
|--|----------|---|---------------------------------------|---------------------------------------|--|
| HB 2490-01 - HB 2490-06 | Ferguson |  | 1 - 6 | ● | 1/2 Kreis; 1/2 circle; 1/2 cercle; 1/2 círculo |
| HB 2491-01 - HB 2491-06 | Ferguson |  | 1 - 6 | ● | 1/2 Kreis; 1/2 circle; 1/2 cercle; 1/2 círculo |
| HB 2492-01 - HB 2492-04 | Mayo |  | 1 - 4 | ● | 1/2 Kreis; 1/2 circle; 1/2 cercle; 1/2 círculo |
| HB 2493-01 - HB 2493-04 | Mayo |  | 1 - 4 | ● | 1/2 Kreis; 1/2 circle; 1/2 cercle; 1/2 círculo |

Wundklammer-Pinzetten
Clip Applying Forceps
Pinces pour agrafes
Pinzas para agrafes

Wundklammer-Zangen
Clip Applying Forceps
Pinces pour agrafes
Pinzas para agrafes



Michel (1x2)
HB 2500 12,0 cm/4¾"



Michel
HB 2505 12,0 cm/4¾"



Hegenbarth
HB 2508 12,5 cm/5"



Wachenfeldt
HB 2509 12,5 cm/5"



Michel
HB 2511 12,0 cm/4¾"

Wundklammer-Zangen
Clip Applying Forceps
Pinces pour agrafes
Pinzas para agrafes



Collin
HB 2515 13,0 cm/5¼"

Taschenbestecke
 Pocket Cases
 Trousses à poche
 Estuches de bolsillo

Wundklammern
 Suture Clips
 Agrafes
 Agrafes



Standard
 HB 2518 165 x 90 x 28 mm

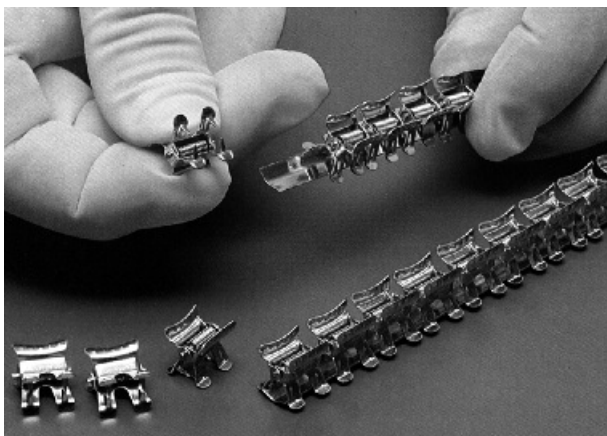

HEBU-Wundsparklammern
 HB 2516

Mindestabnahme: 50 Stück
 Minimum quantity: 50 each
 Quantité minimum: 50 pièces
 Cantidad mínimo: 50 piezas



1 Pack = 100 Stück
 1 Package = 100 each
 1 Paquet = 100 pièces
 1 Paquete = 100 piezas

Michel

| | |
|------------|---------------|
| HB 2519-01 | 7,5 x 1,75 mm |
| HB 2519-02 | 11 x 2 mm |
| HB 2519-03 | 12 x 3 mm |
| HB 2519-04 | 14 x 3 mm |
| Hb 2519-05 | 16 x 3 mm |
| HB 2519-06 | 18 x 3 mm |
| HB 2519-07 | 20 x 3 mm |
| HB 2519-08 | 22 x 3 mm |

Mindestabnahme: 10 Pack
 Minimum quantity: 10 packages
 Quantité minimum: 10 paquets
 Cantidad mínimo: 10 paquetes

**Unterbindungsnadeln
Ligature Needles
Aiguilles à ligatures
Agujas para ligaduras**



links gebogen
für die rechte
Hand

curved to the left,
for the right
hand

courbe à gauche
pour la main
droite

curva a la izquierda,
para la mano
derecha

rechts gebogen
für die linke
Hand

curved to the right,
for the left
hand

courbe à droite
pour la main
gauche

curva a la derecha,
para la mano
izquierda

links gebogen
für die rechte
Hand

curved to the left,
for the right
hand

courbe à gauche
pour la main
droite

curva a la izquierda,
para la mano
derecha

rechts gebogen
für die linke
Hand

curved to the right,
for the left
hand

courbe à droite
pour la main
gauche

curva a la derecha,
para la mano
izquierda

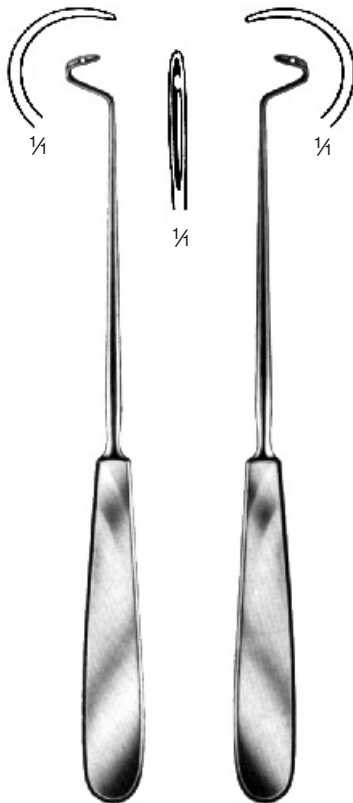

Deschamps

HB 2530-20
20,0 cm/8"
stumpf
blunt
mousse
roma

Deschamps

HB 2531-20
20,0 cm/8"
stumpf
blunt
mousse
roma

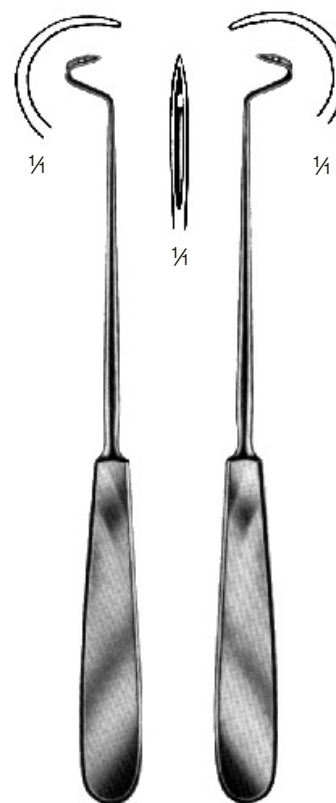

Deschamps

HB 2532-20
20,0 cm/8"
scharf
sharp
pointue
aguda

Deschamps

HB 2533-20
20,0 cm/8"
scharf
sharp
pointue
aguda

**Unterbindungsnadeln
Ligature Needles
Aiguilles à ligatures
Agujas para ligaduras**



links gebogen
für die rechte
Hand

curved to the left,
for the right
hand

courbe à gauche
pour la main
droite

curva a la izquierda,
para la mano
derecha

rechts gebogen
für die linke
Hand

curved to the right,
for the left
hand

courbe à droite
pour la main
gauche

curva a la derecha,
para la mano
izquierda

links gebogen
für die rechte
Hand

curved to the left,
for the right
hand

courbe à gauche
pour la main
droite

curva a la izquierda,
para la mano
derecha

rechts gebogen
für die linke
Hand

curved to the right,
for the left
hand

courbe à droite
pour la main
gauche

curva a la derecha,
para la mano
izquierda

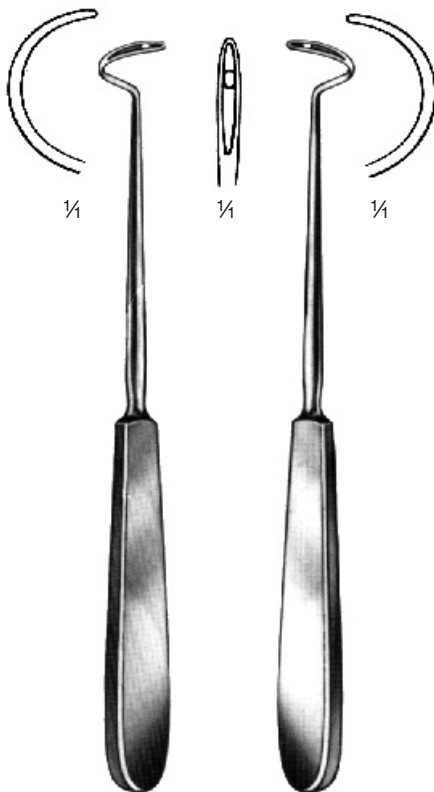

Deschamps

HB 2534-20
20,0 cm/8"
stumpf
blunt
mousse
roma

Deschamps

HB 2535-20
20,0 cm/8"
stumpf
blunt
mousse
roma

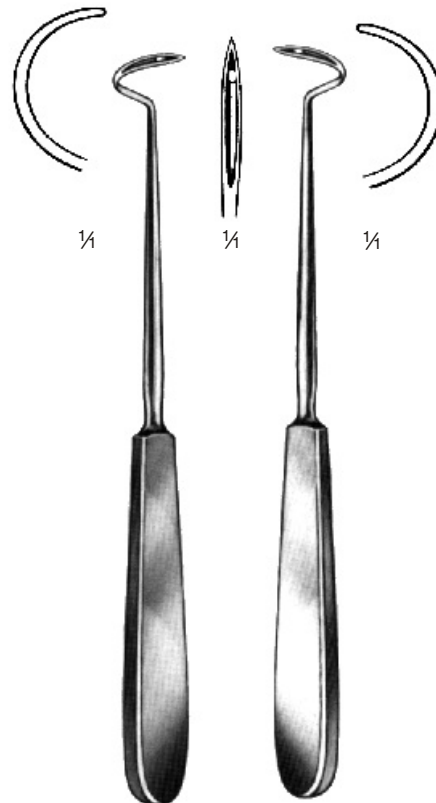

Deschamps

HB 2536-20
20,0 cm/8"
scharf
sharp
pointue
aguda

Deschamps

HB 2537-20
20,0 cm/8"
scharf
sharp
pointue
aguda

Unterbindungsnadeln
Ligature Needles
Aiguilles à ligatures
Agujas para ligaduras



links gebogen
für die rechte
Hand

curved to the left,
for the right
hand

courbe à gauche
pour la main
droite

curva a la izquierda,
para la mano
derecha

rechts gebogen
für die linke
Hand

curved to the right,
for the left
hand

courbe à droite
pour la main
gauche

curva a la derecha,
para la mano
izquierda

links gebogen
für die rechte
Hand

curved to the left,
for the right
hand

courbe à gauche
pour la main
droite

curva a la izquierda,
para la mano
derecha

rechts gebogen
für die linke
Hand

curved to the right,
for the left
hand

courbe à droite
pour la main
gauche

curva a la derecha,
para la mano
izquierda

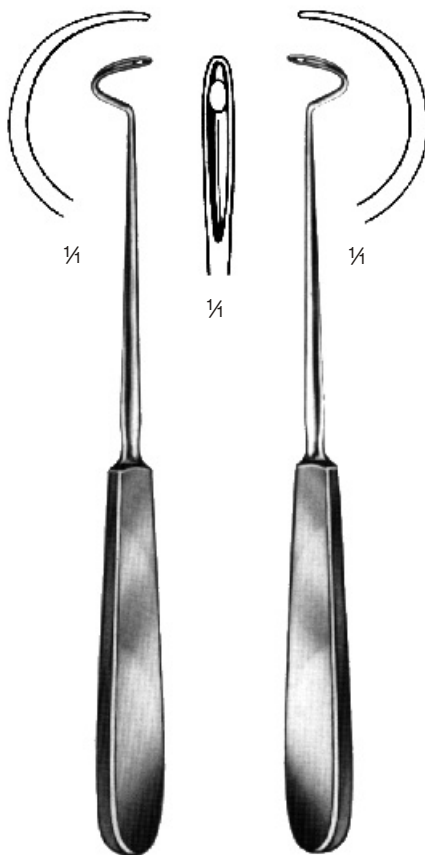

Deschamps

HB 2538-21
21,0 cm/8¼"
stumpf
blunt
mousse
roma

Deschamps

HB 2539-21
21,0 cm/8¼"
stumpf
blunt
mousse
roma

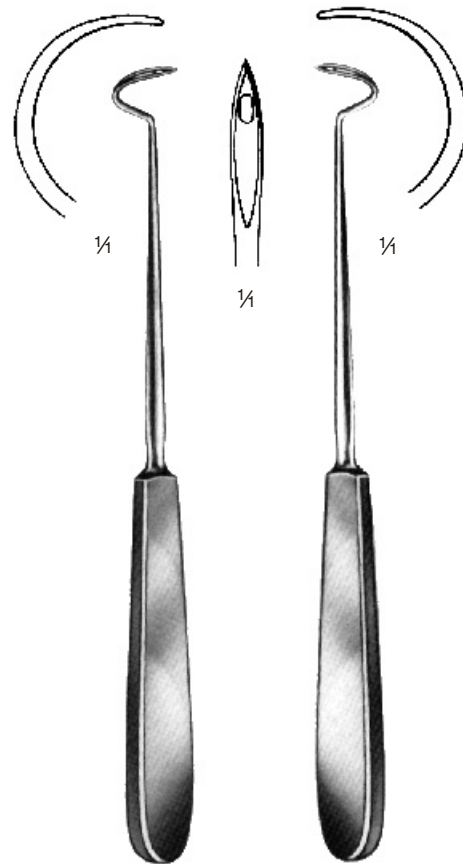

Deschamps

HB 2540-21
21,0 cm/8¼"
scharf
sharp
pointue
aguda

Deschamps

HB 2541-21
21,0 cm/8¼"
scharf
sharp
pointue
aguda

Unterbindungsnadeln
Ligature Needles
Aiguilles à ligatures
Agujas para ligaduras



links gebogen
für die rechte
Hand

curved to the left,
for the right
hand

courbe à gauche
pour la main
droite

curva a la izquierda,
para la mano
derecha

rechts gebogen
für die linke
Hand

curved to the right,
for the left
hand

courbe à droite
pour la main
gauche

curva a la derecha,
para la mano
izquierda

links gebogen
für die rechte
Hand

curved to the left,
for the right
hand

courbe à gauche
pour la main
droite

curva a la izquierda,
para la mano
derecha

rechts gebogen
für die linke
Hand

curved to the right,
for the left
hand

courbe à droite
pour la main
gauche

curva a la derecha,
para la mano
izquierda

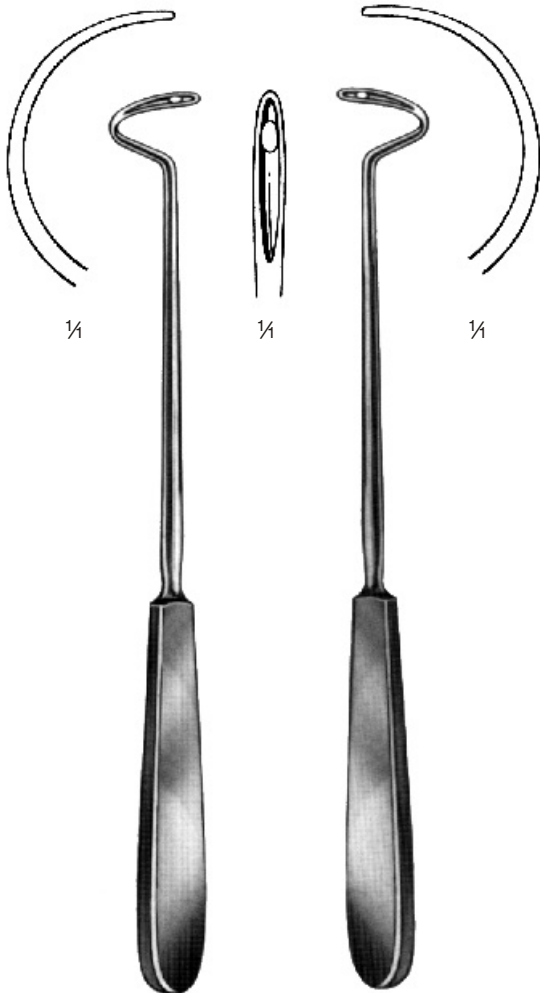

Deschamps

HB 2542-24
24,0 cm/9½"
stumpf
blunt
mousse
roma

Deschamps

HB 2543-24
24,0 cm/9½"
stumpf
blunt
mousse
roma

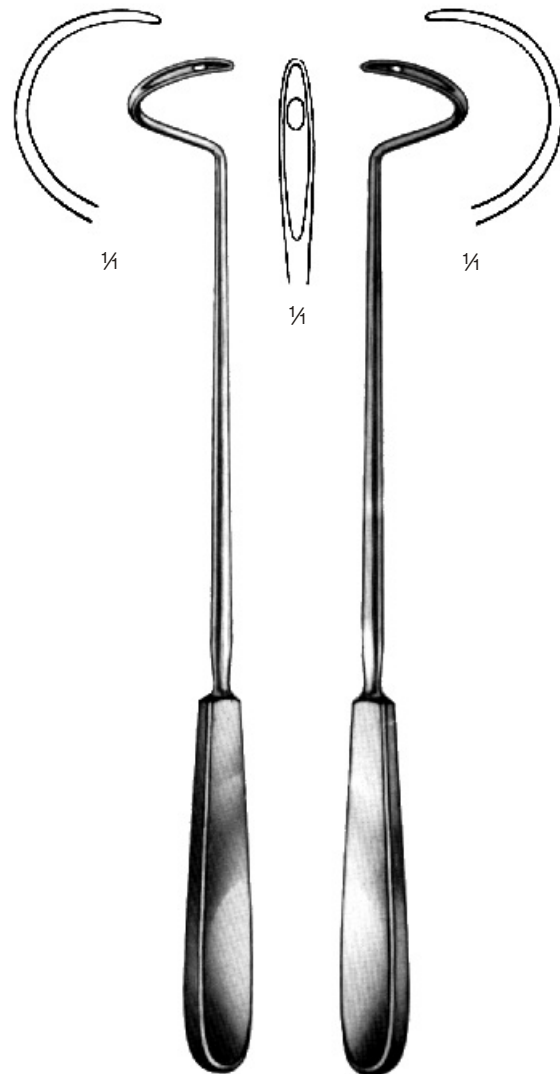

Deschamps

HB 2544-27
27,0 cm/10½"
stumpf
blunt
mousse
roma

Deschamps

HB 2545-27
27,0 cm/10½"
stumpf
blunt
mousse
roma

**Unterbindungsnadeln
Ligature Needles
Aiguilles à ligatures
Agujas para ligaduras**



links gebogen
für die rechte
Hand

curved to the left,
for the right
hand

courbe à gauche
pour la main
droite

curva a la izquierda,
para la mano
derecha

rechts gebogen
für die linke
Hand

curved to the right,
for the left
hand

courbe à droite
pour la main
gauche

curva a la derecha,
para la mano
izquierda

links gebogen
für die rechte
Hand

curved to the left,
for the right
hand

courbe à gauche
pour la main
droite

curva a la izquierda,
para la mano
derecha

rechts gebogen
für die linke
Hand

curved to the right,
for the left
hand

courbe à droite
pour la main
gauche

curva a la derecha,
para la mano
izquierda

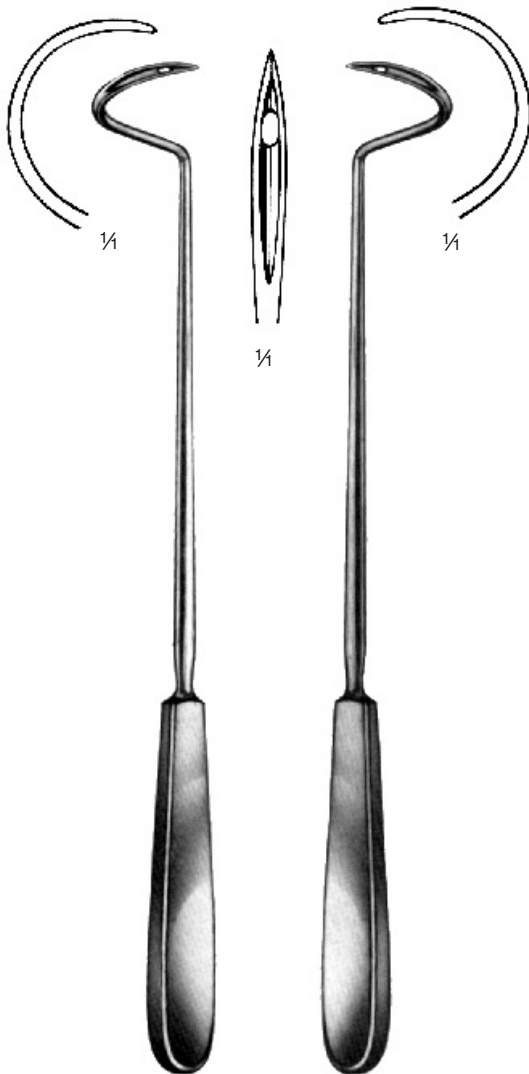

Deschamps

Deschamps

HB 2546-27
27,0 cm/10½"
scharf
sharp
pointue
aguda

HB 2547-27
27,0 cm/10½"
scharf
sharp
pointue
aguda

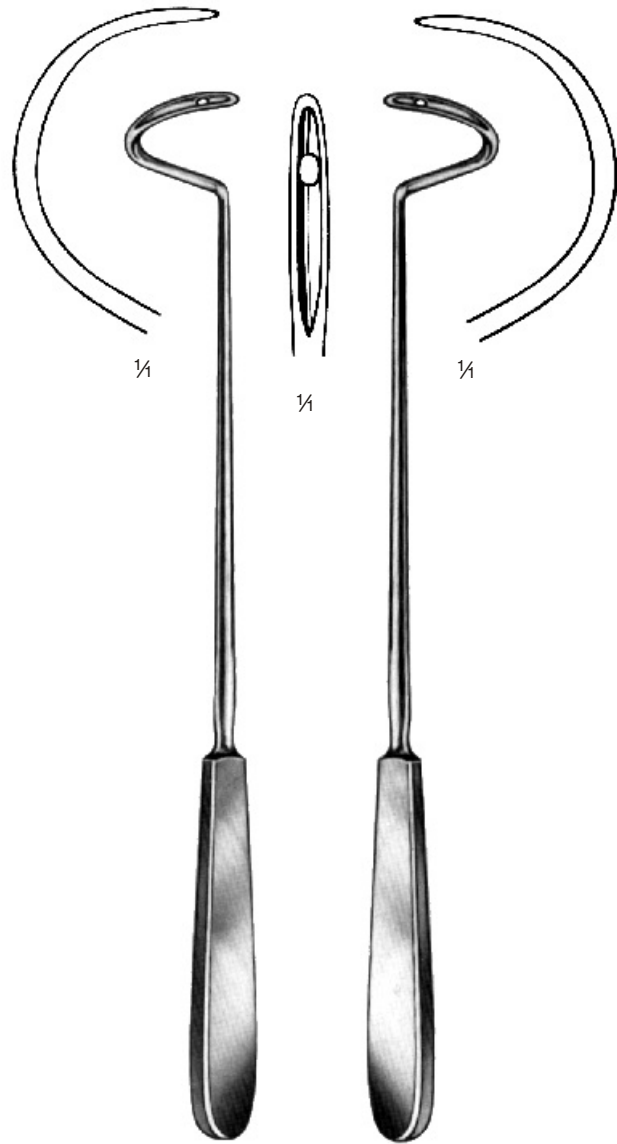

Deschamps

Deschamps

HB 2548-28
28,0 cm/11"
stumpf
blunt
mousse
roma

HB 2549-28
28,0 cm/11"
stumpf
blunt
mousse
roma

Unterbindungsnadeln
Ligature Needles
Aiguilles à ligatures
Agujas para ligaduras



links gebogen
für die rechte
Hand

curved to the left,
for the right
hand

courbe à gauche
pour la main
droite

curva a la izquierda,
para la mano
derecha

rechts gebogen
für die linke
Hand

curved to the right,
for the left
hand

courbe à droite
pour la main
gauche

curva a la derecha,
para la mano
izquierda



Kronecker

HB 2550-01
13,0 cm/5"

Kronecker

HB 2550-02
13,0 cm/5"

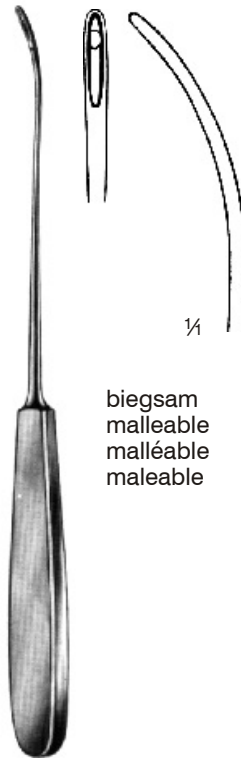

biegsam
malleable
malléable
maleable

HB 2551-01
20,0 cm/8"

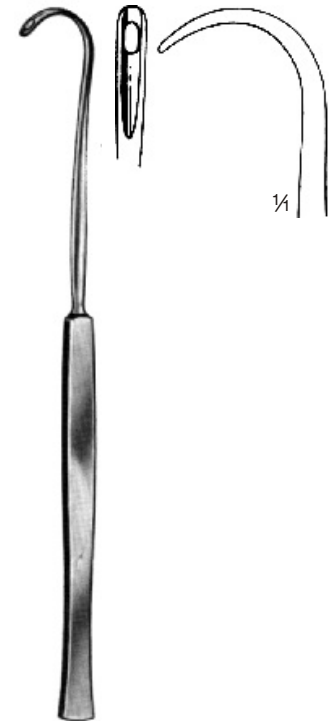

Cooper

HB 2551-02
19,0 cm/7½"



biegsam
malleable
malléable
maleable

Schmieden-Dick

HB 2552-32
32,0 cm/12½"



Schmieden

HB 2553-21
21,0 cm/8¼"

**Unterbindungsnadeln
Ligature Needles
Aiguilles à ligatures
Agujas para ligaduras**



Hessberg

HB 2554-15
15,0 cm/6"



Woodruff
13,0 cm/5"

| | |
|------------|------------|
| HB 2555-01 | HB 2555-02 |
| rechts | links |
| right | left |
| à droite | à gauche |
| derecha | izquierda |

links gebogen
für die rechte
Hand

rechts gebogen
für die linke
Hand

curved to the left,
for the right
hand

curved to the right,
for the left
hand

courbe à gauche
pour la main
droite

courbe à droite
pour la main
gauche

curva a la izquierda,
para la mano
derecha

curva a la derecha,
para la mano
izquierda



HB 2556-01



HB 2556-02

De la Roza
12,0 cm/4¾"



¼

Narath

HB 2557-22

reproduced

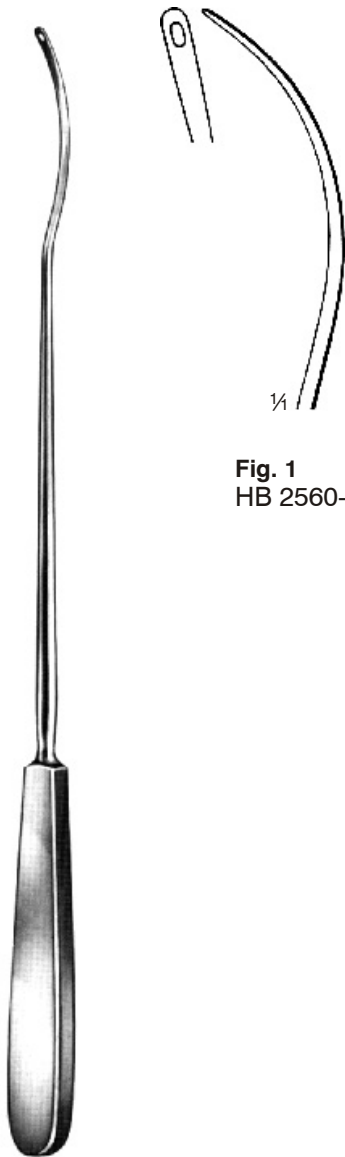

Fig. 1
 HB 2560-01



Fig. 2
 HB 2560-02

Brunner
 30,0 cm/12"

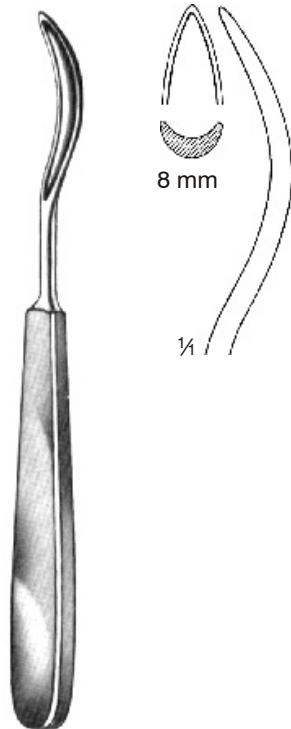

Fig. 3
 HB 2560-03



Fig. 4
 HB 2560-04

Brunner
 30,0 cm/12"



Schmieden

HB 2561-01
 19,0 cm/7½"

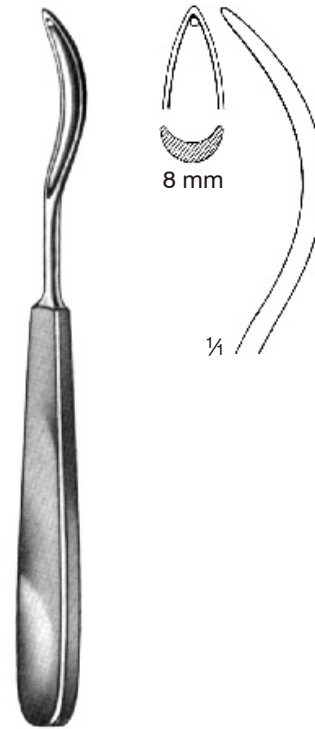

Schmieden-Payr

HB 2561-02
 19,0 cm/7½"

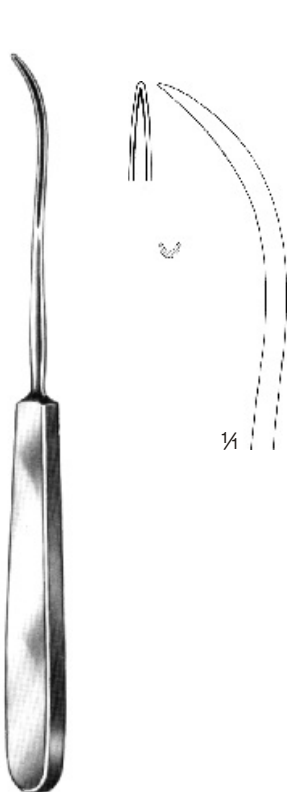

König

HB 2562-01
 19,5 cm/7¾"

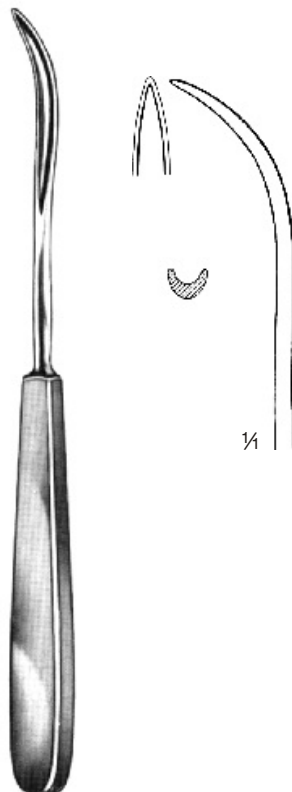

König

HB 2562-02
 19,5 cm/7¾"

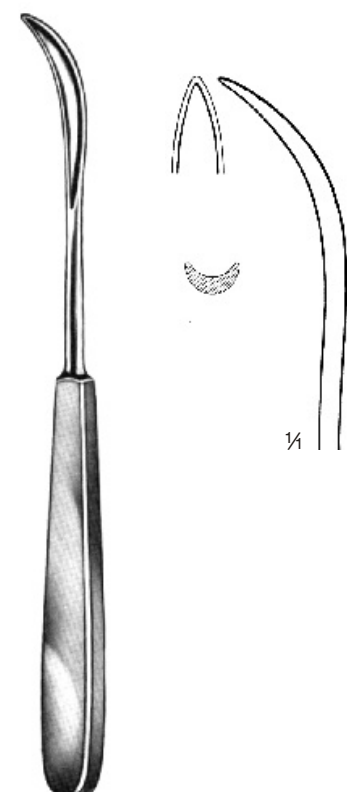

König

HB 2562-03
 20,0 cm/8"



Payr

Fig. 1
 HB 2563-01
 22,0 cm/8³/₄"



Payr

Fig. 2
 HB 2563-02
 22,0 cm/8³/₄"



1/4



HB 2564-25
 19,5 cm/7³/₄"



Kocher



11 mm

1/4

15,0 cm/6"

HB 2565-01



11 mm

HB 2565-02



12 mm

HB 2565-03

1/4

17,0 cm/7"



Brunner-Ferrozell

HB 2566-18 18,0 cm/7"

HB 2566-27 27,0 cm/10¹/₂"

Reverdin-Nadeln
 Reverdin Needles
 Aiguilles de Reverdin
 Agujas de Reverdin



Reverdin
 14,0 cm/5½"



Fig. 1
 HB 2570-01



Fig. 2
 HB 2570-02



Fig. 3
 HB 2570-03



Fig. 4
 HB 2570-04



Reverdin
 19,5 cm/7¾"



Fig. 1
 HB 2571-01



Fig. 2
 HB 2571-02



Fig. 3
 HB 2571-03



Fig. 4
 HB 2571-04



Reverdin
22,5 cm/8 $\frac{3}{4}$ "



Fig. 1
HB 2572-01



Fig. 2
HB 2572-02



Fig. 3
HB 2572-03



Fig. 4
HB 2572-04

