

Verschiedene Klemmen
Miscellaneous Forceps
Pinces diverses
Pinzas diversas



Bulldogklemmen
Bulldog Clamps
Clamps Bulldog
Clamps Bulldog

Arterienklemmen
Hemostatic Forceps
Pinças hémostatiques
Pinzas hemostáticas



HB 497



HB 498

Dieffenbach
6,0 cm/2½"



3,5 cm/1½"
HB 499 HB 501



5,0 cm/2"
HB 500 HB 502

Dieffenbach



John Hopkins

HB 505 5,0 cm/2"
 HB 506 6,5 cm/2½"
 HB 507 7,5 cm/3"



HB 503 micro
HB 508

Hartmann
10,0 cm/4"



HB 504 micro
HB 509

**Arterienklemmen
Hemostatic Forceps
Pincers hémostatiques
Pinzas hemostáticas**



Halsted-Mosquito

HB 510	12,5 cm/5"	HB 515
HB 511	14,0 cm/5½"	HB 516
HB 514 micro	12,5 cm/5"	HB 519 micro
gerade		gebogen
straight		curved
droite		courbe
recta		curva



Halsted-Mosquito 1:2

HB 520	12,5 cm/5"	HB 525
HB 521	14,0 cm/5½"	HB 526
HB 529 micro	12,5 cm/5"	HB 530 micro
gerade		gebogen
straight		curved
droite		courbe
recta		curva

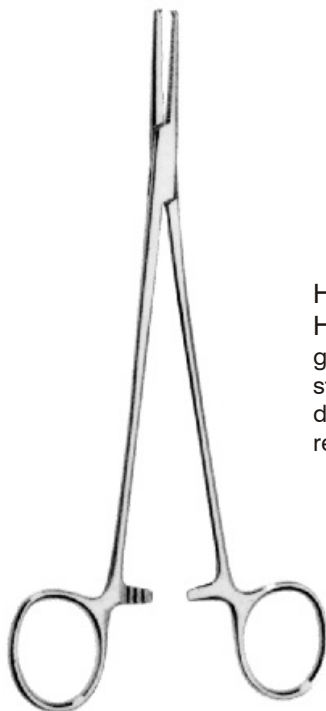

HB 512	18,0 cm/7"
HB 513	21,0 cm/8¼"
gerade	
straight	
droite	
recta	

Halsted-Mosquito

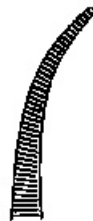

HB 517
HB 518
gebogen
curved
courbe
curva



HB 522	18,0 cm/7"
HB 523	21,0 cm/8¼"
gerade	
straight	
droite	
recta	

Halsted-Mosquito 1:2

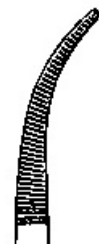

HB 527
HB 528
gebogen
curved
courbe
curva

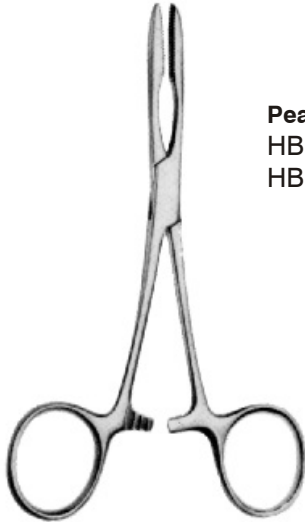

Pean
 HB 531 14,0 cm/5½"
 HB 532 16,0 cm/6¼"



Pean
 14,0 cm/5½"
 fein, delicate, fine, fina

HB 538
 gerade, straight,
 droite, recta

HB 540
 gebogen, curved,
 courbe, curva

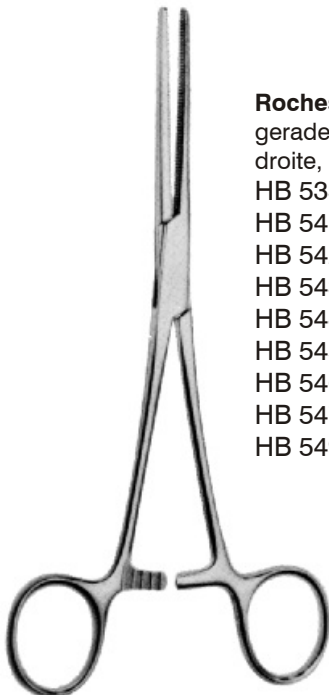

Rochester-Pean
 gerade, straight,
 droite, recta
 HB 533 13,0 cm/5"
 HB 541 14,0 cm/5½"
 HB 542 16,0 cm/6¼"
 HB 543 18,0 cm/7"
 HB 544 20,0 cm/8"
 HB 545 22,0 cm/8¾"
 HB 546 24,0 cm/9½"
 HB 547 26,0 cm/10¼"
 HB 549 30,0 cm/12"

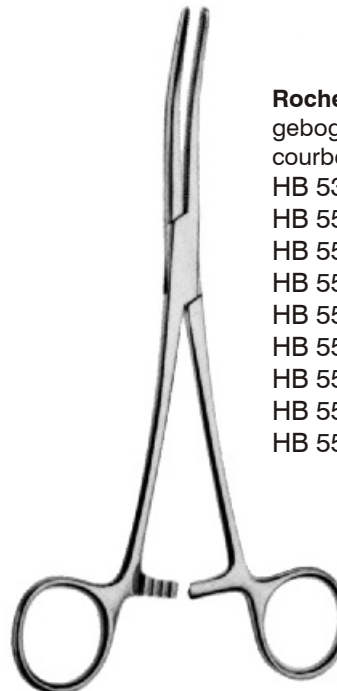

Rochester-Pean
 gebogen, curved,
 courbe, curva
 HB 535 13,0 cm/5"
 HB 551 14,0 cm/5½"
 HB 552 16,0 cm/6¼"
 HB 553 18,0 cm/7"
 HB 554 20,0 cm/8"
 HB 555 22,0 cm/8¾"
 HB 556 24,0 cm/9½"
 HB 557 26,0 cm/10¼"
 HB 559 30,0 cm/12"

Arterienklemmen
Hemostatic Forceps
Pinces hémostatiques
Pinzas hemostáticas



Kocher
 14,0 cm/5½"
 fein, delicate, fine, fina

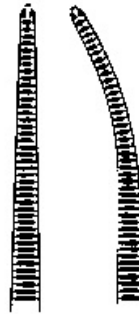

HB 566
 gerade
 straight
 droite
 recta

HB 568
 gebogen
 curved
 courbe
 curva

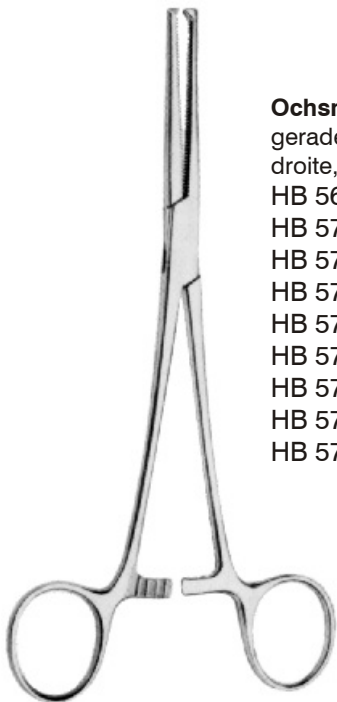

Ochsner-Kocher
 gerade, straight,
 droite, recta
 HB 561 13,0 cm/5"
 HB 571 14,0 cm/5½"
 HB 572 16,0 cm/6¼"
 HB 573 18,0 cm/7"
 HB 574 20,0 cm/8"
 HB 575 22,0 cm/8¾"
 HB 576 24,0 cm/9½"
 HB 577 26,0 cm/10¼"
 HB 579 30,0 cm/12"

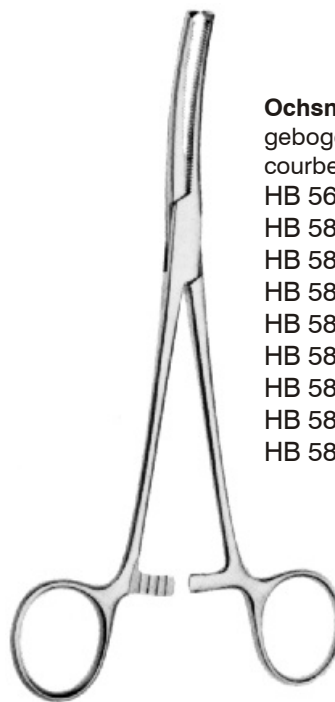

Ochsner-Kocher
 gebogen, curved,
 courbe, curva
 HB 563 13,0 cm/5"
 HB 581 14,0 cm/5½"
 HB 582 16,0 cm/6¼"
 HB 583 18,0 cm/7"
 HB 584 20,0 cm/8"
 HB 585 22,0 cm/8¾"
 HB 586 24,0 cm/9½"
 HB 587 26,0 cm/10¼"
 HB 589 30,0 cm/12"

Arterienklemmen
 Hemostatic Forceps
 Pincés hémostatiques
 Pinzas hemostáticas



Rochester-Carmalt



HB 591
 HB 593
 gerade
 straight
 droite
 recta

16,0 cm/6¼"
 20,0 cm/8"



HB 595
 HB 597
 gebogen
 curved
 courbe
 curva

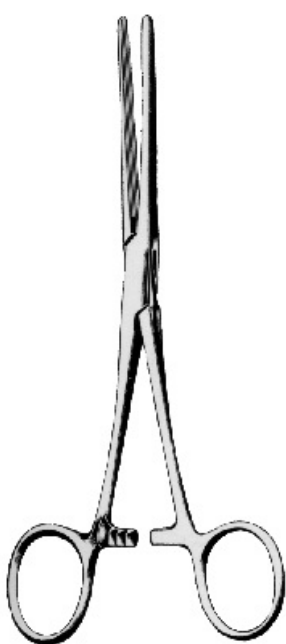

Bainbridge
 15 cm/6"



HB 596
 gerade
 straight
 droite
 recta



HB 598
 gebogen
 curved
 courbe
 curva

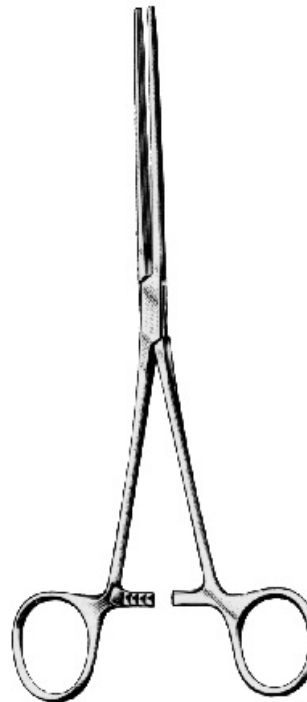

Bainbridge
 18,5 cm/7¼"



HB 599
 gerade
 straight
 droite
 recta



HB 600
 gebogen
 curved
 courbe
 curva

Arterienklemmen
 Hemostatic Forceps
 Pincés hémostatiques
 Pinzas hemostáticas



Kelly
 14,0 cm/5½"



HB 601
 gerade
 straight
 droite
 recta



HB 602
 gebogen
 curved
 courbe
 curva



Kelly-Rankin
 16,0 cm/6¼"



HB 603
 gerade
 straight
 droite
 recta

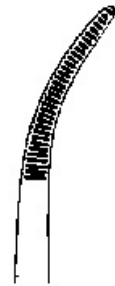

HB 604
 gebogen
 curved
 courbe
 curva

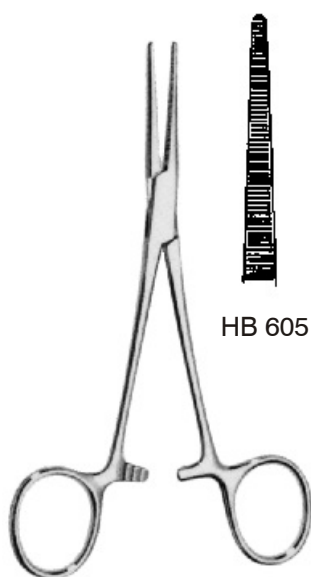

HB 605



HB 606



HB 607

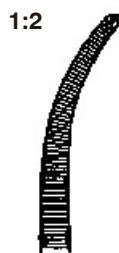

1:2

HB 608

Crile
 14,0 cm/5½"



HB 609
 gerade
 straight
 droite
 recta

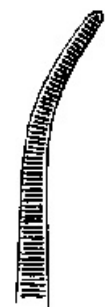

HB 610
 gebogen
 curved
 courbe
 curva

Crile-Rankin
 16,0 cm/6¼"

**Arterienklemmen
Hemostatic Forceps
Pincers hémostatiques
Pinzas hemostáticas**



HB 611
gerade
straight
droite
recta

Providence Hospital
14,0 cm/5½"

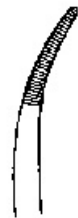

HB 612
gebogen
curved
courbe
curva



Lovelace
HB 614 15,5 cm/6"

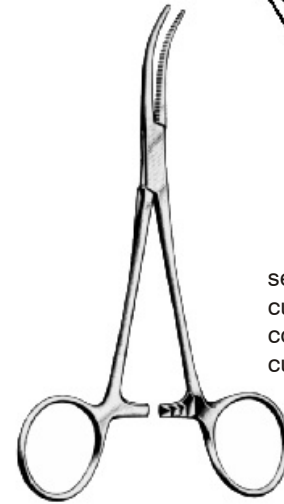

seitwärts gebogen
curved on side
courbe sur le côté
curva lateral

Dandy Crile
HB 615 14,0 cm/5½"



HB 617 14,0 cm/5½"
HB 619 16,0 cm/6¼"
gerade
straight
droite
recta

Baby-Crile



HB 618
HB 620
gebogen
curved
courbe
curva



Spencer-Wells



HB 621 13,0 cm/5"
HB 622 14,0 cm/5½"
HB 623 15,5 cm/6"
HB 624 18,0 cm/7"
HB 625 20,0 cm/8"
HB 626 24,0 cm/9"
gerade
straight
droite
recta

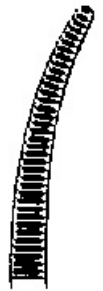

HB 627
HB 628
HB 629
HB 630
HB 631
HB 632
gebogen
curved
courbe
curva

Arterienklemmen
 Hemostatic Forceps
 Pincés hémostatiques
 Pinzas hemostáticas



HB 634
 gerade
 straight
 droite
 recta

Leriche
 15,0 cm/6"



HB 635
 gebogen
 curved
 courbe
 curva



Pennington

HB 636 15,5 cm/6"
 HB 637 20,0 cm/8"

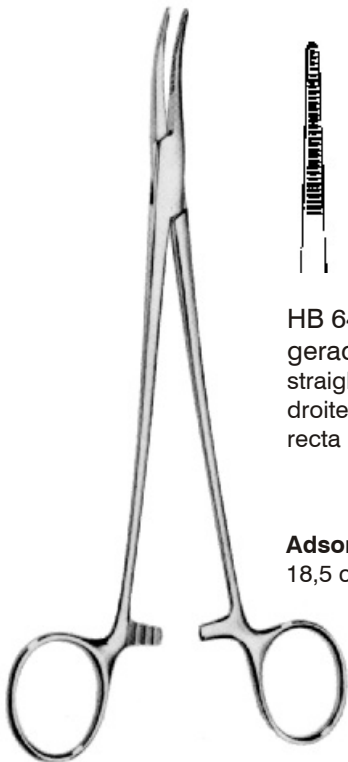

HB 640
 gerade
 straight
 droite
 recta

Adson
 18,5 cm/7¼"



HB 641
 gebogen
 curved
 courbe
 curva

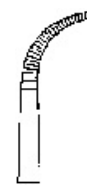

HB 642
 14,0 cm/5½"

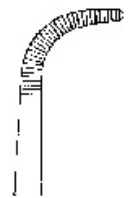

HB 643
 18,0 cm/7"

Baby-Adson

Arterienklemmen
 Hemostatic Forceps
 Pincès hémostatiques
 Pinzas hemostáticas

Präparier- und Ligaturklemmen
 Dissecting and Ligature Forceps
 Pincès à disséquer et à ligatures
 Pinzas para preparaciones y ligaduras

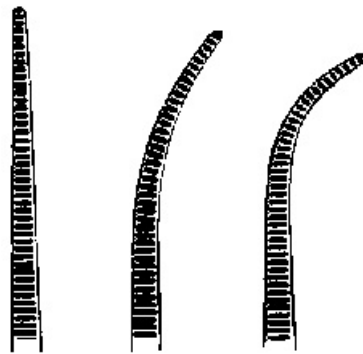
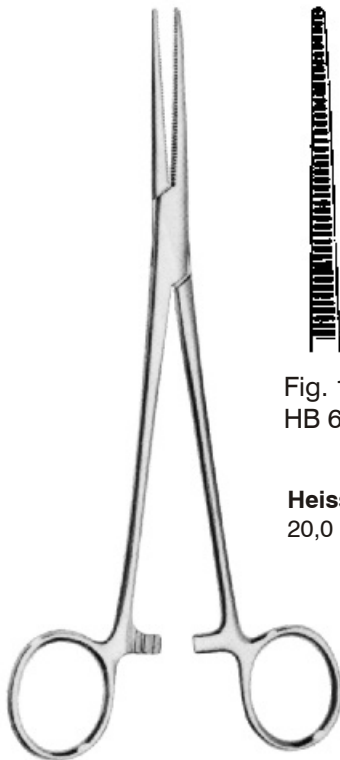

Fig. 1 HB 644
 Fig. 2 HB 645
 Fig. 3 HB 646

Arterienklemmen
 Hemostatic Forceps
 Pincès hémostatiques
 Pinzas hemostáticas

Heiss
 20,0 cm/8"

Präparier- und Ligaturklemmen, Dissecting and Ligature Forceps
 Pincès à disséquer et à ligatures, Pinzas para preparaciones y ligaduras

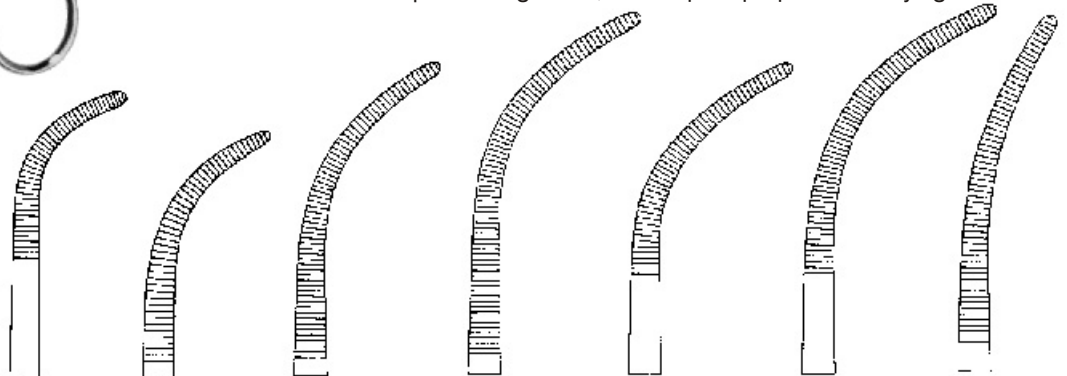

Fig. 1 19,5cm/7¼" HB 650-01
 Fig. 2 21,0cm/8¼" HB 650-02
 Fig. 3 22,0cm/8¾" HB 650-03
 Fig. 4 22,5cm/9" HB 650-04
 Fig. 5 21,5cm/8½" HB 650-05
 Fig. 6 22,5cm/9" HB 650-06
 Fig. 7 22,5cm/9" HB 650-07

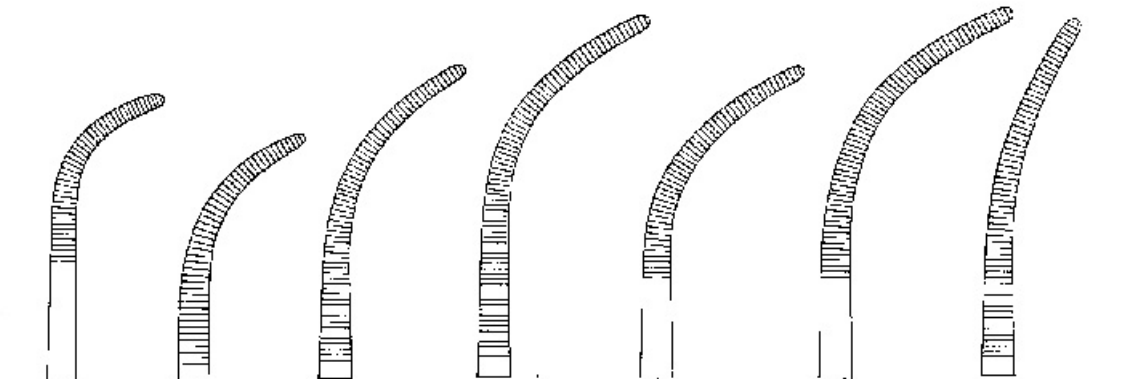
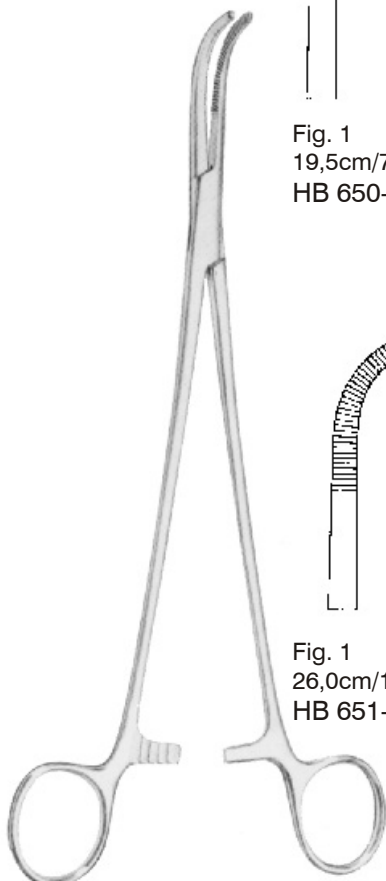
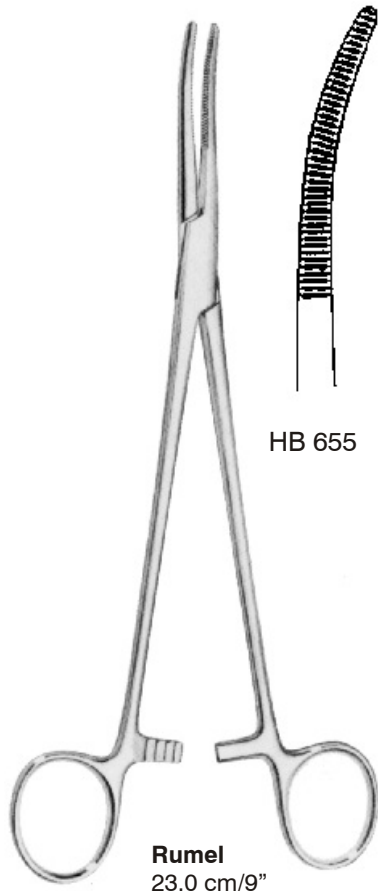

Fig. 1 26,0cm/10¼" HB 651-01
 Fig. 2 27,0cm/10½" HB 651-02
 Fig. 3 27,5cm/10¾" HB 651-03
 Fig. 4 27,5cm/10¾" HB 651-04
 Fig. 5 27,5cm/10¾" HB 651-05
 Fig. 6 28,0cm/11" HB 651-06
 Fig. 7 27,5cm/10¾" HB 651-07

Overholt-Geissendoerfer

Arterienklemmen
 Hemostatic Forceps
 Pincès hémostatiques
 Pinzas hemostáticas

Präparierklemmen
 Dissecting Forceps
 Pincès à disséquer
 Pinzas para preparaciones



Rumel
 23,0 cm/9"

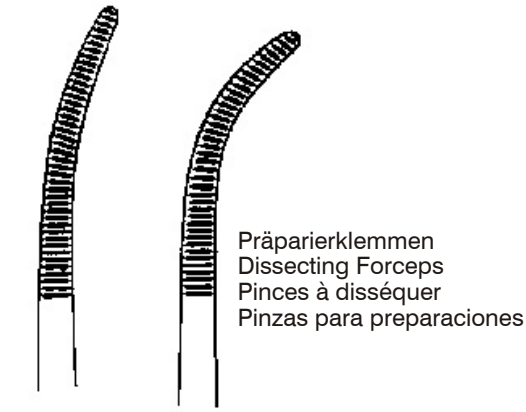

HB 655

HB 656

Präparierklemmen
 Dissecting Forceps
 Pincès à disséquer
 Pinzas para preparaciones

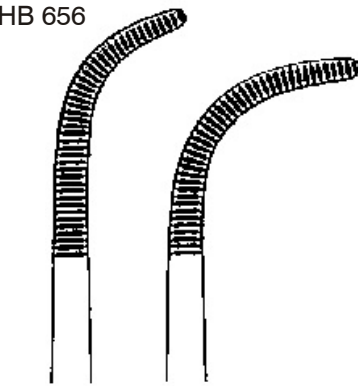

HB 657

HB 658

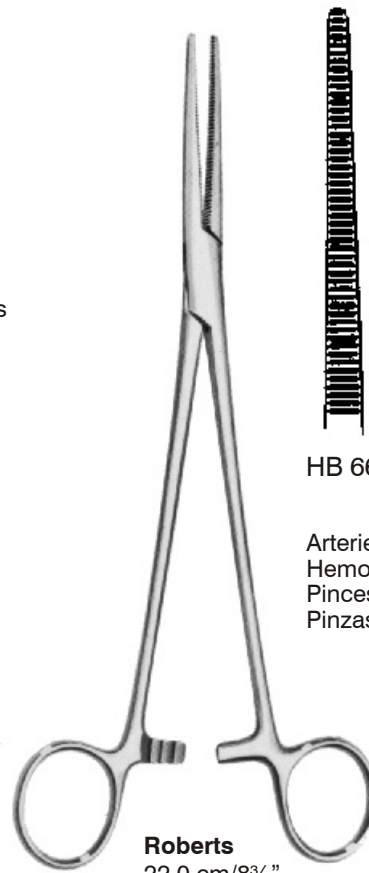

Roberts
 22,0 cm/8¾"

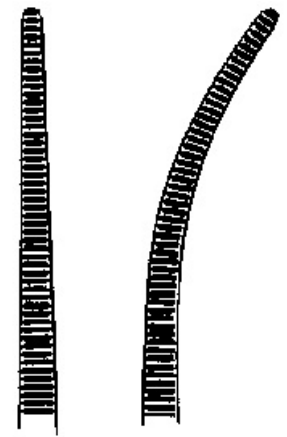

HB 660

HB 661

Arterienklemmen
 Hemostatic Forceps
 Pincès hémostatiques
 Pinzas hemostáticas



Crafoord
 24,0 cm/9½"

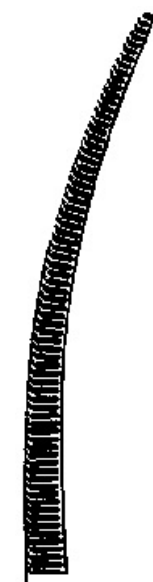

HB 662

Arterienklemmen
 Hemostatic Forceps
 Pincès hémostatiques
 Pinzas hemostáticas

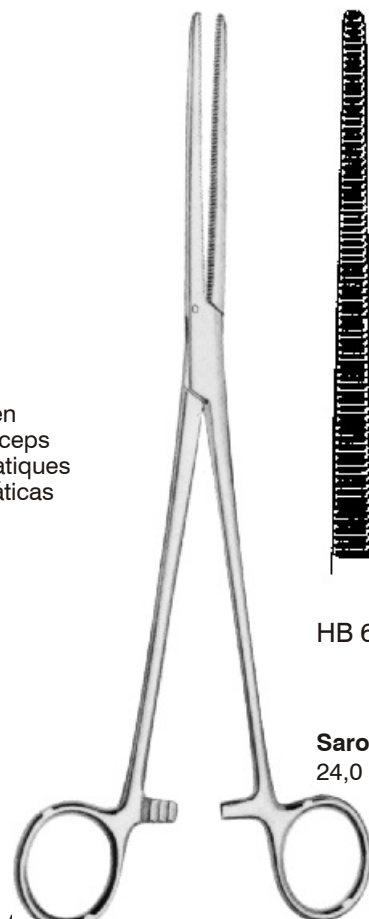

Sarot
 24,0 cm/9½"

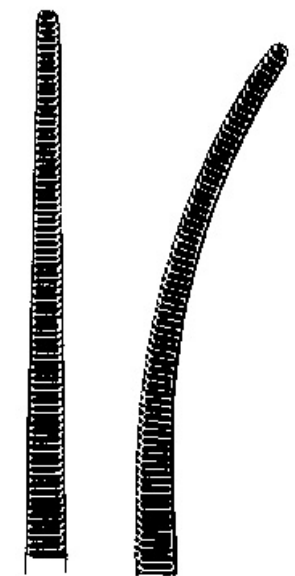

HB 665

HB 666

Arterienklemmen
 Hemostatic Forceps
 Pinces hémostatiques
 Pinzas hemostáticas



Bengolea

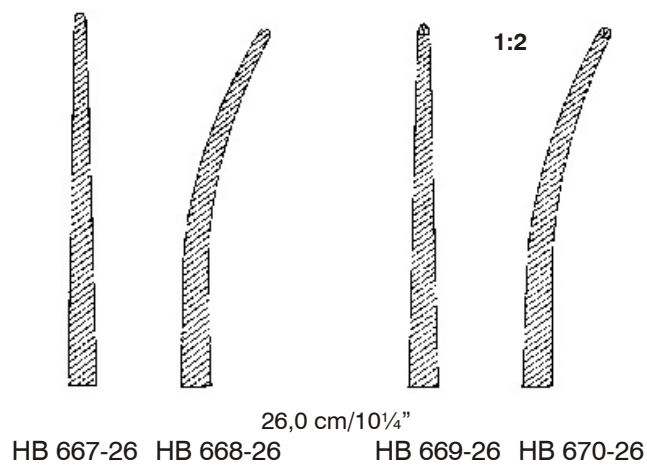
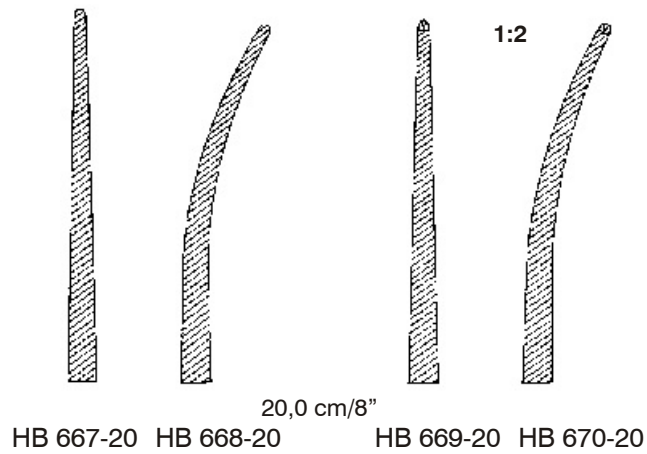

Präparier- und Ligaturklemmen
Dissecting and Ligature Forceps
Pincès à disséquer et à ligatures
Pinzas para preparaciones y ligaduras



Mini-Gemini

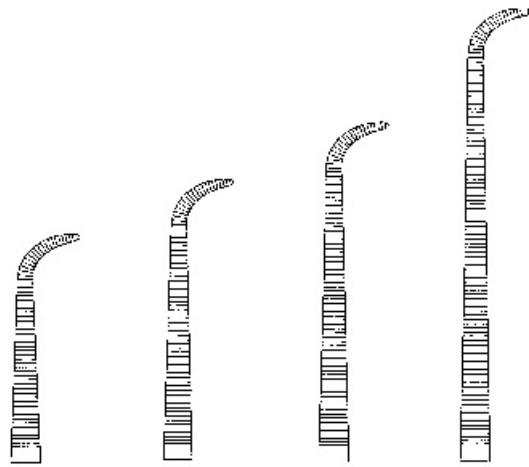

18,0 cm/7" HB 671-18 22,0 cm/8³/₄" HB 671-22 25,0 cm/10" HB 671-25 28,0 cm/11" HB 671-28



Gemini

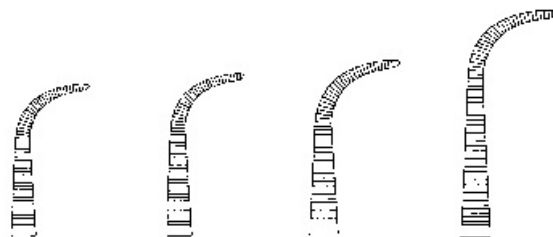

13,0 cm/5" HB 672-13 14,0 cm/5¹/₂" HB 672-14 16,0 cm/6¹/₄" HB 672-16 18,0 cm/7" HB 672-18

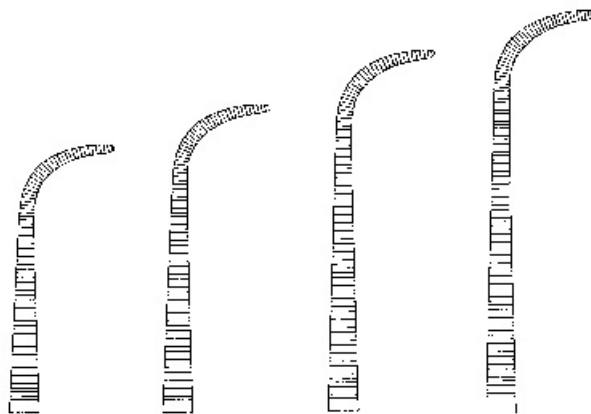

20,0 cm/8" HB 672-20 23,0 cm/9" HB 672-23 25,0 cm/10" HB 672-25 28,0 cm/11" HB 672-28

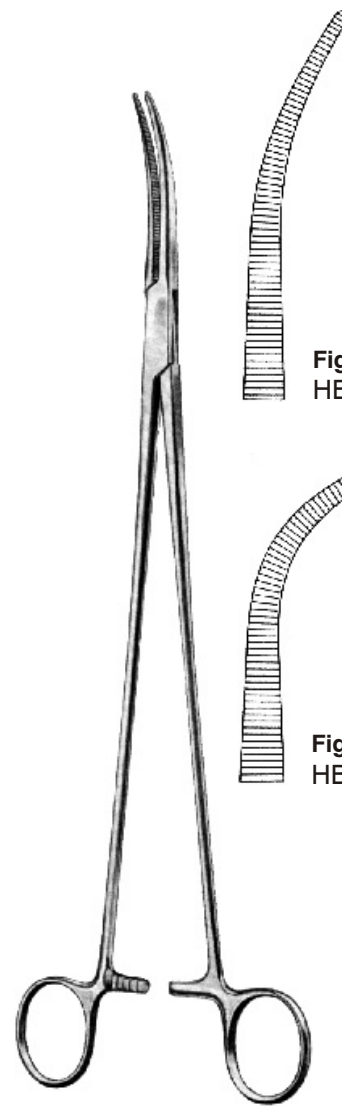

Zenker
29,5 cm/11¹/₂"

Fig. 1
HB 673-01

Fig. 2
HB 673-02

Arterienklemmen
 Hemostatic Forceps
 Pincès hémostatiques
 Pinzas hemostáticas



Mixer-Baby
 HB 675 14,0 cm/5½"
 HB 675-18 18,0 cm/7"



Mixer
 HB 676 15,5 cm/6"
 HB 677 19,0 cm/7½"

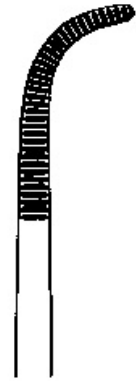
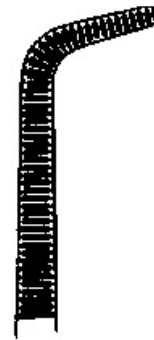

HB 678
 22,0 cm/8¾"



Mixer-O'Shaugnessy
 HB 679 15,5 cm/6"
 HB 680 19,0 cm/7½"

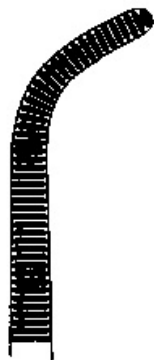

Negus
 19,0 cm/7½"



HB 681

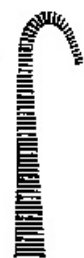

HB 682

Arterienklemmen
 Hemostatic Forceps
 Pincès hémostatiques
 Pinzas hemostáticas

Gallenkanalklemmen
 Gall Duct Clamps
 Pincès pour voies biliaires
 Pinzas para conductos biliares

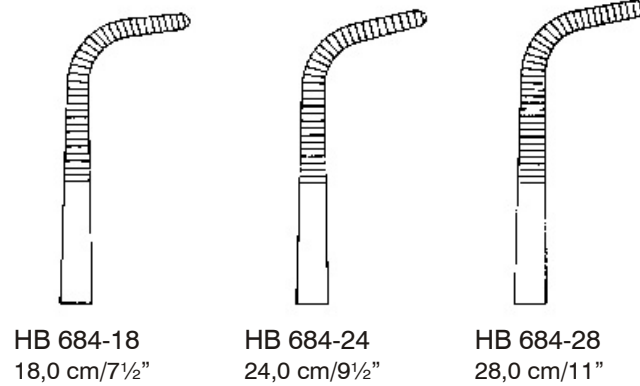

Kantrowitz

Gallenkanalklemmen
 Gall Duct Clamps
 Pincès pour voies biliaires
 Pinzas para conductos biliares

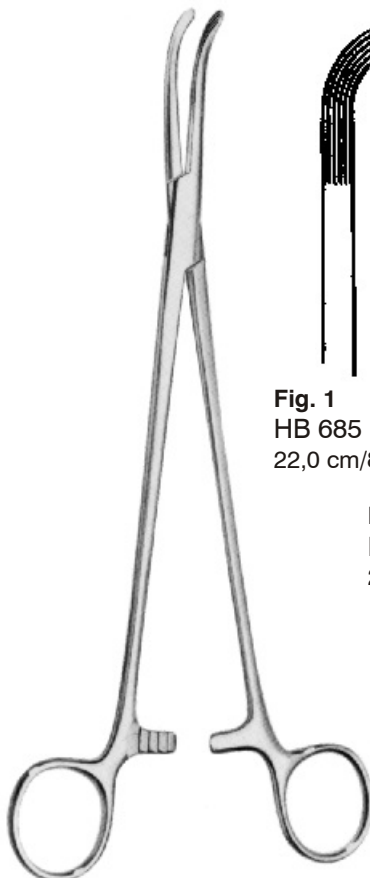
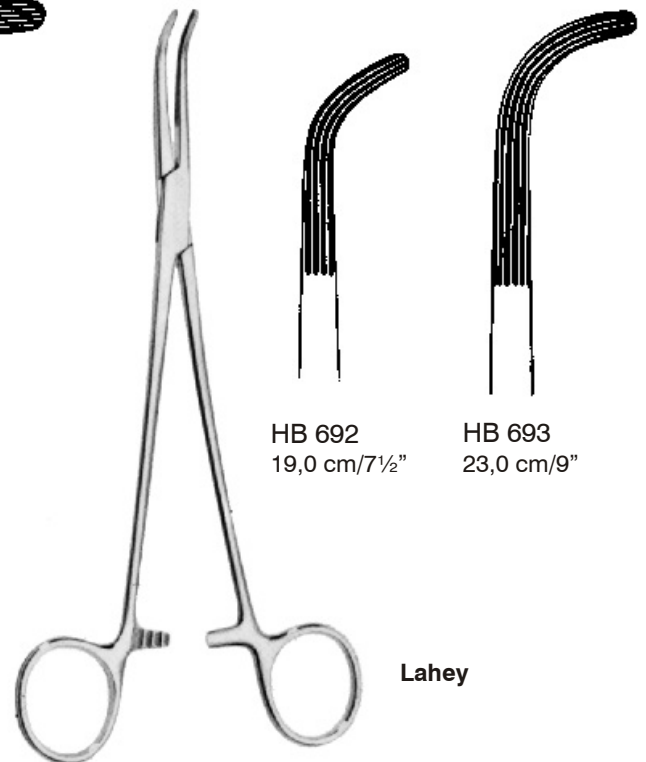

Fig. 1
 HB 685
 22,0 cm/8¾"

Fig. 2
 HB 686
 25,0 cm/10"

Fig. 3
 HB 687
 28,0 cm/11"

Mixer



HB 692
 19,0 cm/7½"

HB 693
 23,0 cm/9"

Lahey

Klemmzangen **Hysterektomieklemmen**
Clamp Forceps **Hysterectomy Forceps**
Pinces clamps **Pinces à hystérectomie**
Pinzas-clamps **Pinzas para histerectomia**

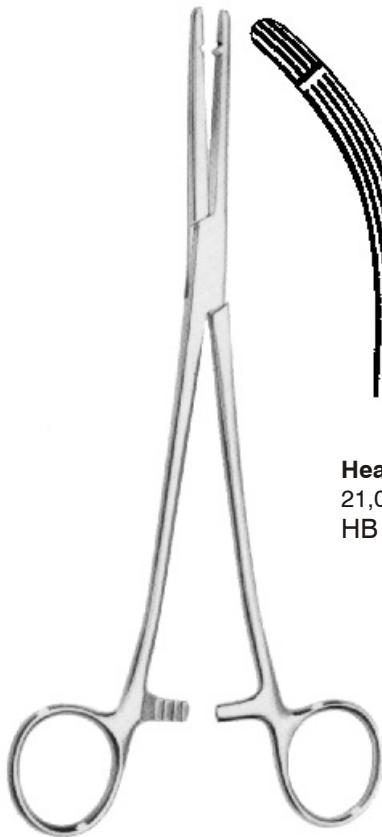

Heaney-Ballentine
 21,0 cm/8¼"
 HB 712 HB 713

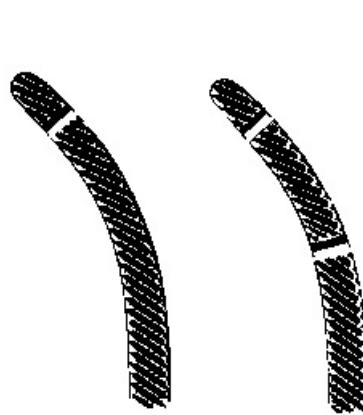

Heaney
 HB 715 19,0 cm/7¾" HB 721
 HB 716 21,0 cm/8¼" HB 722
 HB 717 23,0 cm/9" HB 723

Hysterektomieklemmen
 Hysterectomy Forceps
 Pinces à hystérectomie
 Pinzas para histerectomia

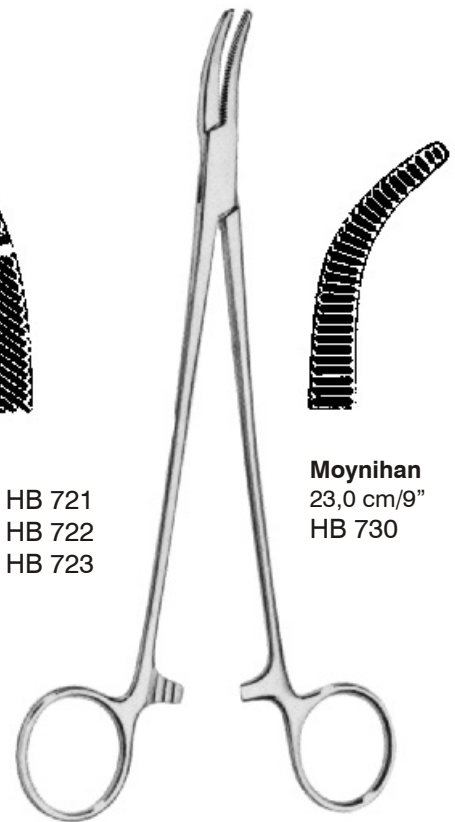

Moynihan
 23,0 cm/9"
 HB 730



Wertheim-Cullen
 21,5 cm/8½"
 HB 732



Wertheim
 25,0 cm/10"
 HB 733

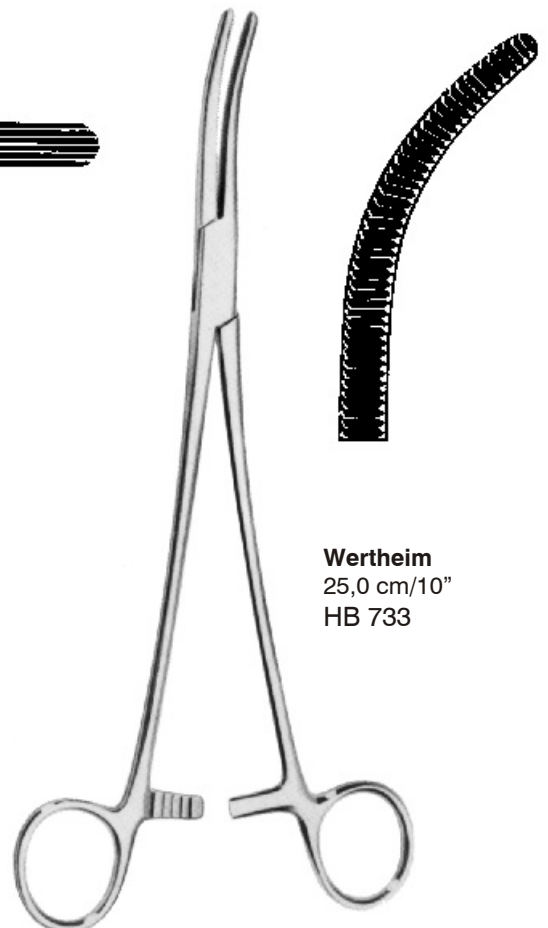

Klemmzangen **Hysterektomieklemmen**
Clamp Forceps **Hysterectomy Forceps**
Pinces clamps **Pinces à hystérectomie**
Pinzas-clamps **Pinzas para histerectomia**

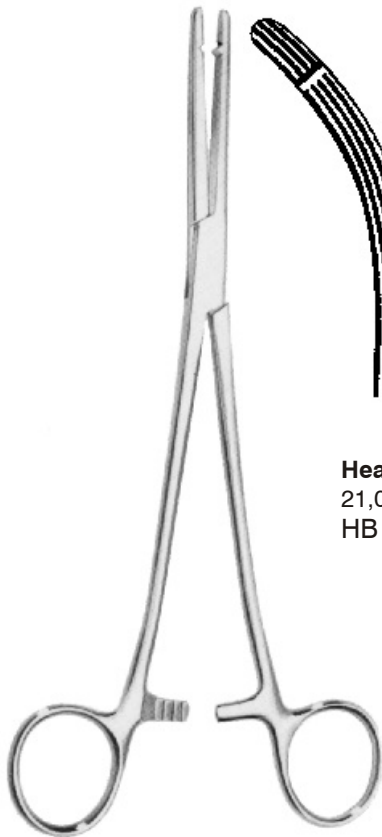

Heaney-Ballentine
 21,0 cm/8¼"
 HB 712 HB 713

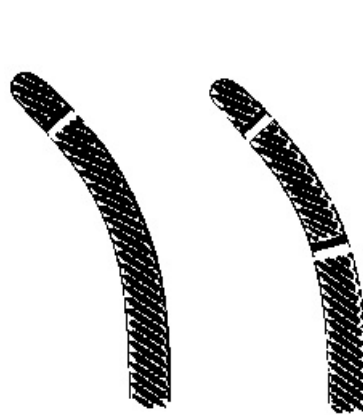

Heaney
 HB 715 19,0 cm/7¾" HB 721
 HB 716 21,0 cm/8¼" HB 722
 HB 717 23,0 cm/9" HB 723

Hysterektomieklemmen
 Hysterectomy Forceps
 Pinces à hystérectomie
 Pinzas para histerectomia

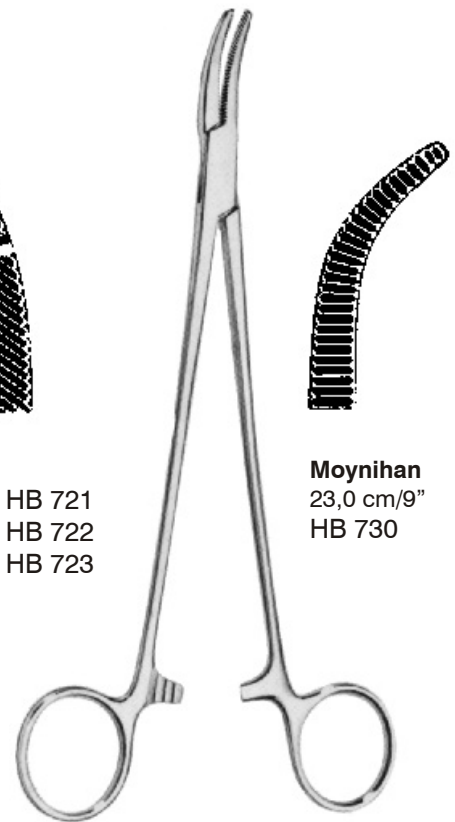

Moynihan
 23,0 cm/9"
 HB 730

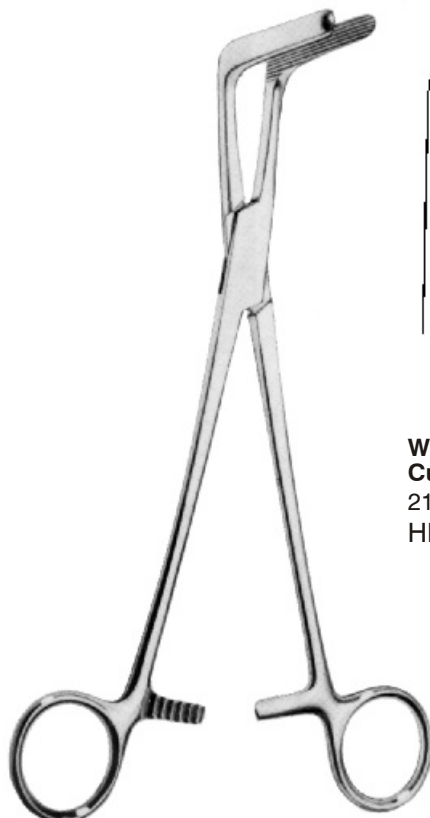

Wertheim-Cullen
 21,5 cm/8½"
 HB 732



Wertheim
 25,0 cm/10"
 HB 733

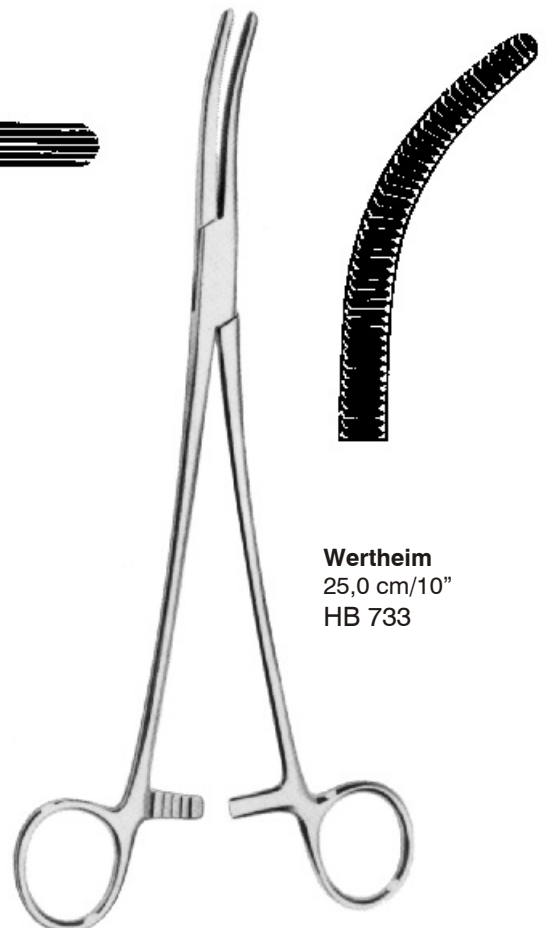

Klemmzangen
Clamp Forceps
Pinces clamps
Pinzas-clamps

Peritoneumklemmen
Peritoneal Clamp Forceps
Pinces pour péritoine
Pinzas para peritoneo

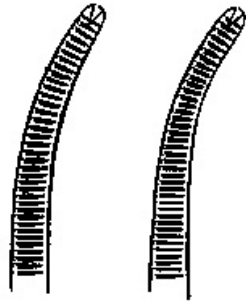

Wertheim
 22,0 cm/8³/₄" 23,0 cm/9"
 HB 734 HB 735

Klemmzangen
 Clamp Forceps
 Pinces clamps
 Pinzas-clamps

Peritoneumklemmen, Peritoneal Clamp Forceps, Pinces pour péritoine, Pinzas para peritoneo

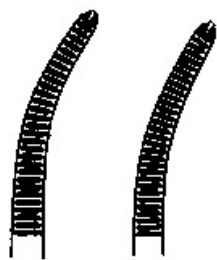

HB 737 HB 738

Mikulicz
 20,0 cm/8"

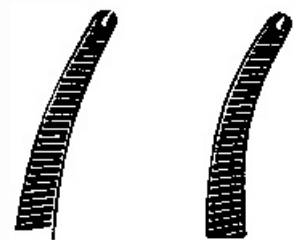

HB 739 HB 740

Faure
 20,0 cm/8"

Tuchklemmen
Towel Forceps
Pinces à champs
Pinzas de campo



Schädel
 9,0 cm/3½"

HB 761
 gebogen
 curved
 courbe
 curva



Jones
 HB 762 5,5 cm/2¼"
 HB 763 9,0 cm/3½"



Doyen
 18,0 cm/7"
 HB 764



Peers
 14,5 cm/5¾"
 HB 770

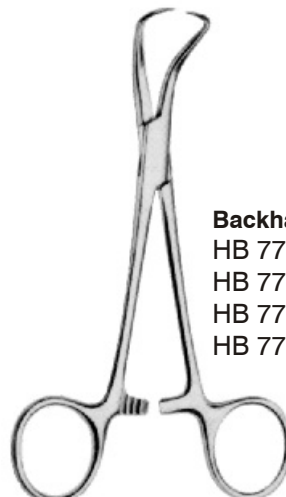

Backhaus
 HB 771 9,0 cm/3½"
 HB 772 11,0 cm/4½"
 HB 773 13,0 cm/5"
 HB 774 15,0 cm/6"

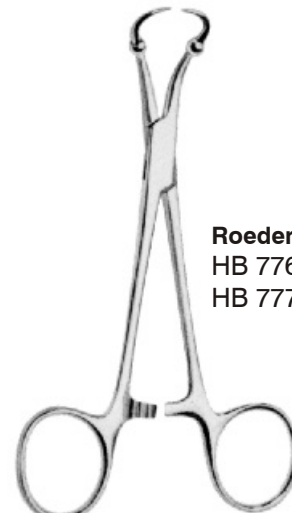

Roeder
 HB 776 13,0 cm/5"
 HB 777 15,0 cm/6"



Bernhard
 16,0 cm/6¼"
 HB 778



Lane
 20,0 cm/8"
 HB 780

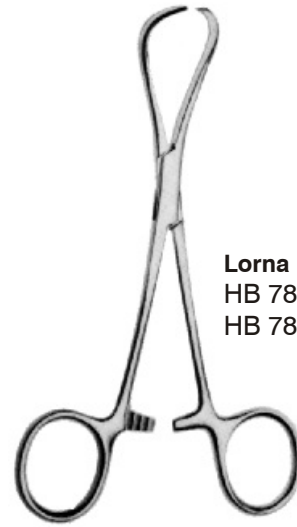

Lorna
 HB 781 10,0 cm/4"
 HB 782 13,0 cm/5"



Ombredanne
 13,5 cm/5½"
 HB 783

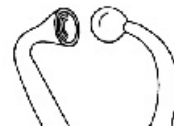

HB 785 11,0 cm/4½"
 HB 786 13,0 cm/5"
 Kugel/Pfanne
 Ball/Socket
 boule/poêle
 bola/paila



HB 787 11,0 cm/4½"
 HB 788 13,0 cm/5"
 Kugel/Kugel
 Ball/Ball
 boule/boule
 bola/bola

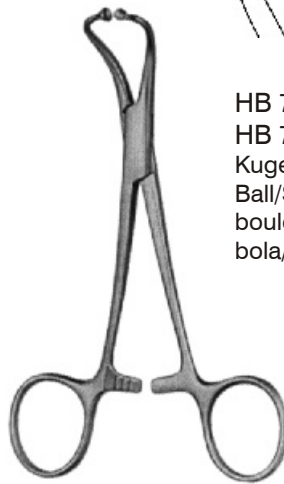

Tuchklemmen
Towel Forceps
Pincès à champs
Pinzas de campo

Schlauchklemmen
Tubing Clamps
Pincès presse-tube
Pinzas para tubos



Tuchklemmen, Towel Forceps, Pincès à champs, Pinzas de campo

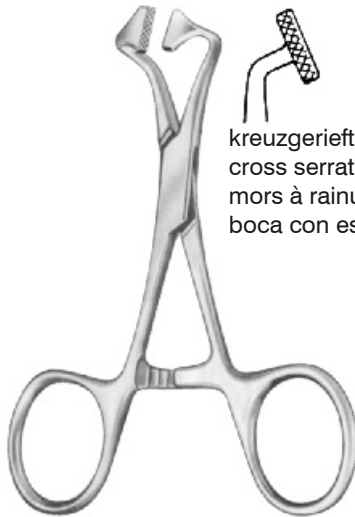

kreuzgerieft
cross serrated
mors à rainures croisées
boca con estrías cruzadas

Thomas
HB 788-10 10,0 cm/4"
HB 788-13 13,0 cm/5"

Schlauchklemmen, Tubing Clamps, Pincès presse-tube, Pinzas para tubos

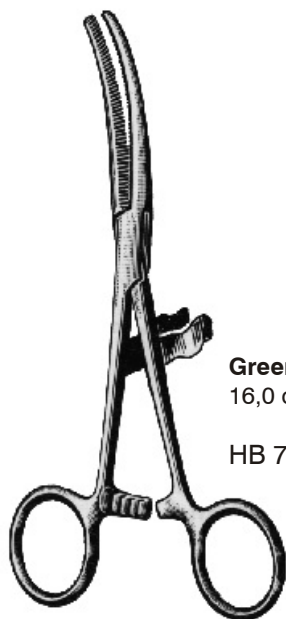

Green
16,0 cm/6¼"
HB 789



Presbyterian
16,0 cm/6½"
HB 790
glatt
smooth
mousse
lisse

Schlauchklemmen
Tubing Clamps
Pinces presse-tube
Pinzas para tubos

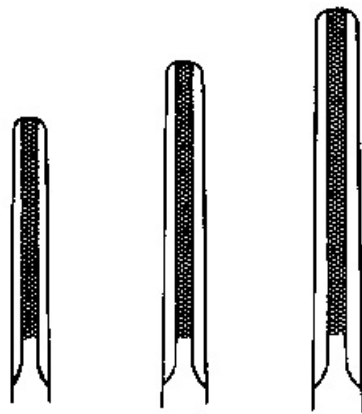

14,0 cm/5½" HB 791 18,0 cm/7" HB 792 20,0 cm/8" HB 793

ohne U
 without guard
 sans protection
 sin protección

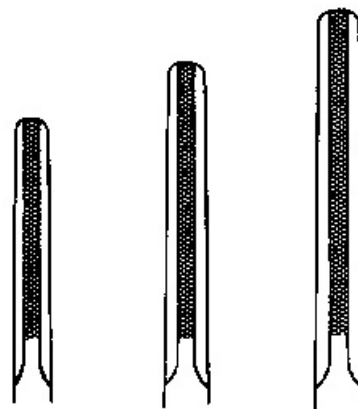

mit U
 with guard
 avec protection
 con protección

14,0 cm/5½" HB 796 18,0 cm/7" HB 797 20,0 cm/8" HB 798

Korn-(Polypen-) zangen
Polypus and Dressing Forceps
Pinces à pansements et à polypes
Pinzas para pólipos y vendajes

Tupferzangen
Cotton Swab Forceps
Pinces à tampons
Pinzas para tampones

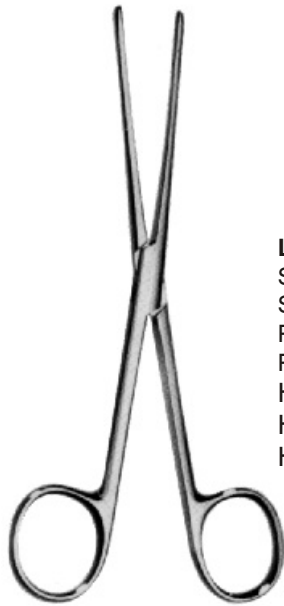

Lister
 Sinusklemmen
 Sinus Forceps
 Pinces à sinus
 Pinzas para seno
 HB 825 13,0 cm/5"
 HB 826 16,0 cm/6¼"
 HB 827 18,0 cm/7"

Korn-(Polypen-) zangen, Polypus and Dressing Forceps
 Pinces à pansements et à polypes, Pinzas para pólipos y vendajes



HB 821
 gerade, straight
 droite, recta

Gross
 20,0 cm/8"

HB 822
 gebogen, curved
 courbe, curva

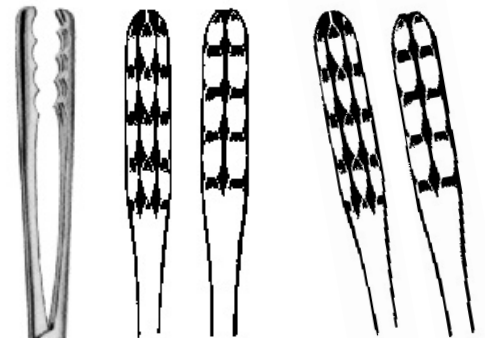

HB 851 22,0 cm/8¾" **HB 853**
HB 852 25,0 cm/10" **HB 854**
 gerade gebogen
 straight curved
 droite courbe
 recta curva

Tupferzangen
 Cotton Swab Forceps
 Pinces à tampons
 Pinzas para tampones

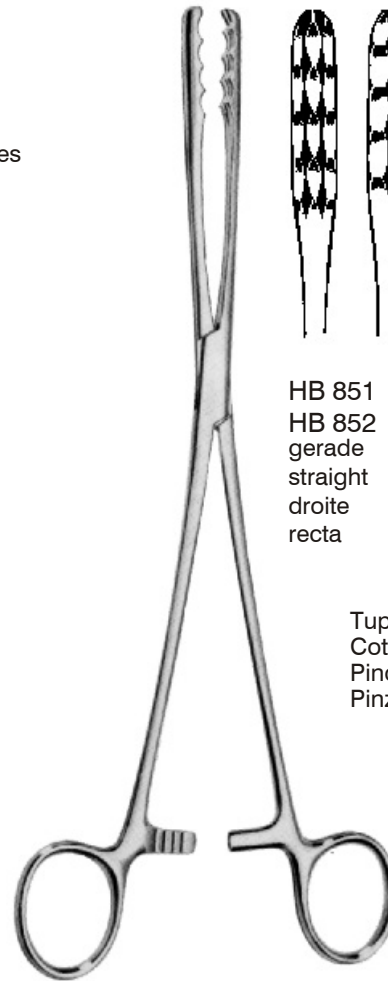

Ulrich

Korn-(Polypen-) zangen
Polypus and Dressing Forceps
Pinces à pansements et à polypes
Pinzas para pólipos y vendajes

Tupferzangen
Cotton Swab Forceps
Pinces à tampons
Pinzas para tampones



HB 855 22,0 cm/8¾" HB 857
 HB 856 25,0 cm/10" HB 858

Korn-(Polypen-) zangen
 Polypus and Dressing Forceps
 Pinces à pansements et à polypes
 Pinzas para pólipos y vendajes

Maier

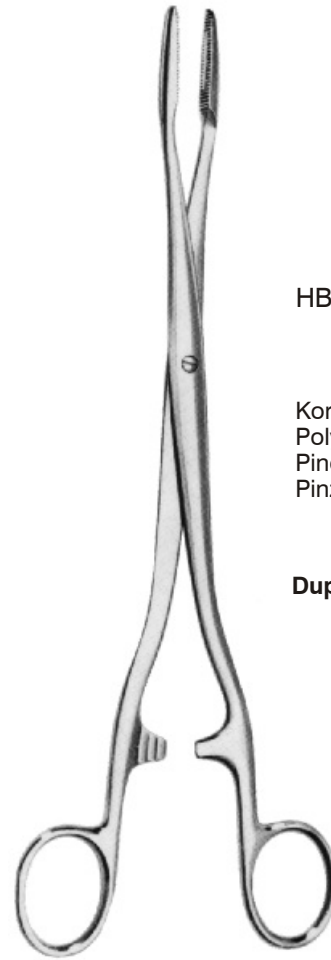

HB 861 25,0 cm/10" HB 862

Korn-(Polypen-) zangen
 Polypus and Dressing Forceps
 Pinces à pansements et à polypes
 Pinzas para pólipos y vendajes

Duplay

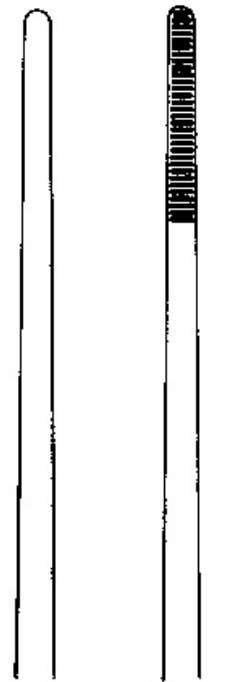

HB 865 HB 866



Bozemann
 26,0 cm/10¼"

Tupferzangen
 Cotton Swab Forceps
 Pinces à tampons
 Pinzas para tampones

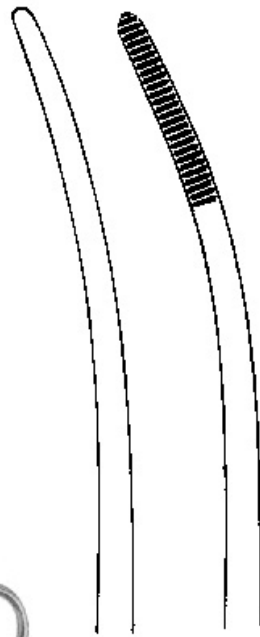

HB 867 HB 868

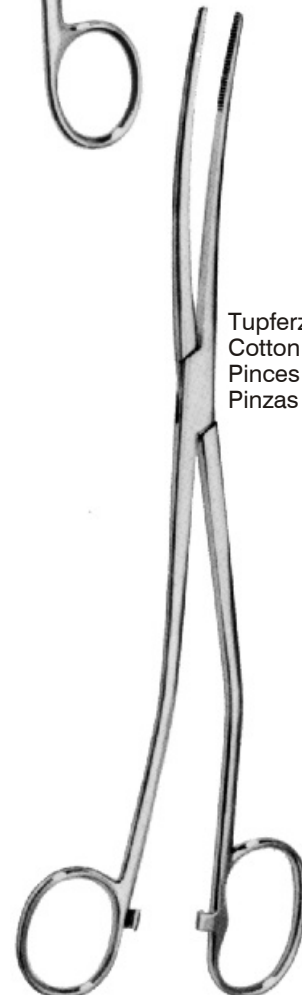

Bozemann-Douglas
 26,0 cm/10¼"
 HB 869

Tupferzangen
 Cotton Swab Forceps
 Pinces à tampons
 Pinzas para tampones

Tupferzangen
Cotton Swab Forceps
Pinces à tampons
Pinzas para tampones

Schwammzangen
Sponge Holding Forceps
Pinces à éponges
Pinzas porta-esponjas



Tupferzangen
 Cotton Swab Forceps
 Pinces à tampons
 Pinzas para tampones

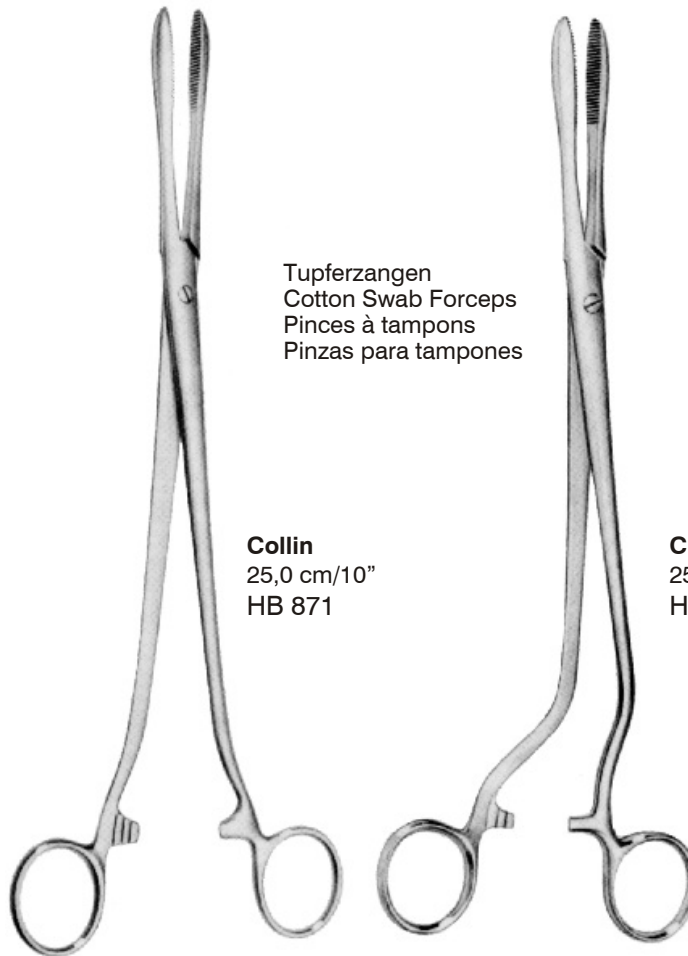

Collin
 25,0 cm/10"
 HB 871

Cheron
 25,0 cm/10"
 HB 873

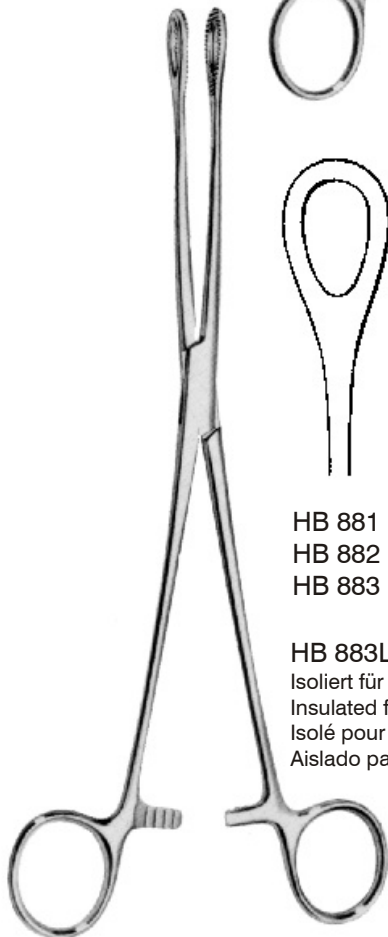

Foerster

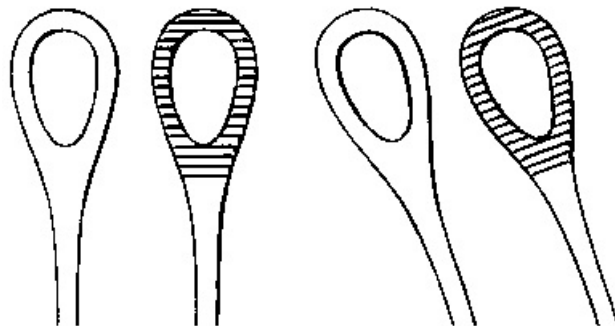

HB 881	HB 884	18,0 cm/7"	HB 887	HB 890
HB 882	HB 885	20,0 cm/8"	HB 888	HB 891
HB 883	HB 886	25,0 cm/10"	HB 889	HB 892

HB 883L 25,0 cm/10"
 Isoliert für Laser- und Elektrochirurgie
 Insulated for Laser- and Electrosurgery
 Isolé pour les interventions au laser et électrochirurgical
 Aislado para láser y electrocirugía

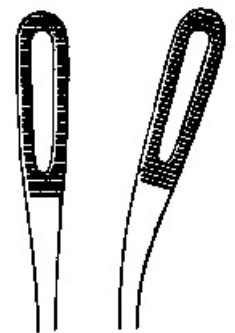

HB 893 HB 894

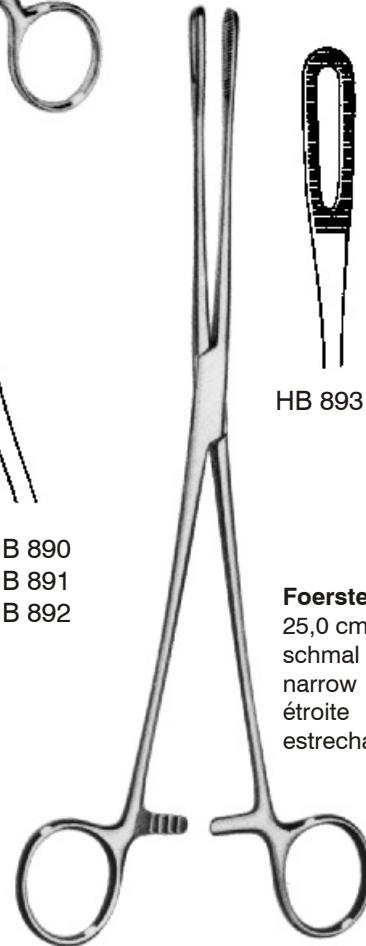

Foerster
 25,0 cm/10"
 schmal
 narrow
 étroite
 estrecha

Schwammzangen
Sponge Holding Forceps
Pinces à éponges
Pinzas porta-esponjas

Sterilisierzangen
Sterilizing Forceps
Pinces à stérilisation
Pinzas para esterilización

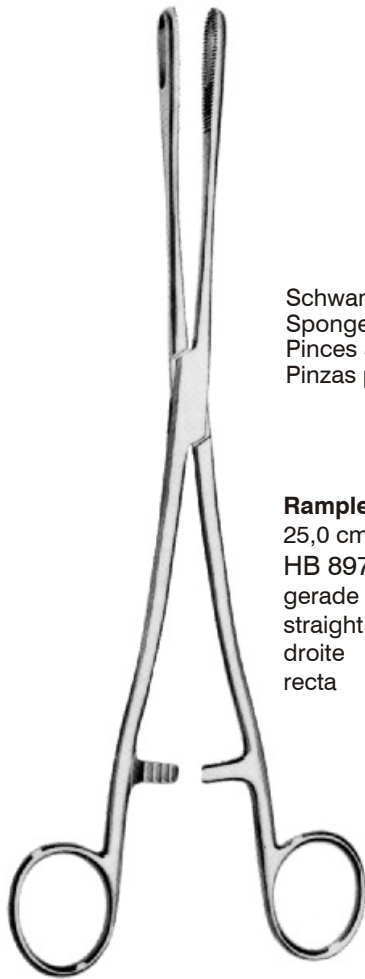

Schwammzange
 Sponge Holding Forceps
 Pinces à éponges
 Pinzas porta-esponjas

Rampley
 25,0 cm/10"
 HB 897
 gerade
 straight
 droite
 recta

HB 898
 gebogen
 curved
 courbe
 curva



Davis
 Sterilisierpinzette
 Sterilizing Forceps
 Pinces à stérilisation
 Pinzas para esterilización
 HB 901 16,0 cm/6¼"
 HB 902 20,0 cm/8"
 HB 903 24,0 cm/9½"

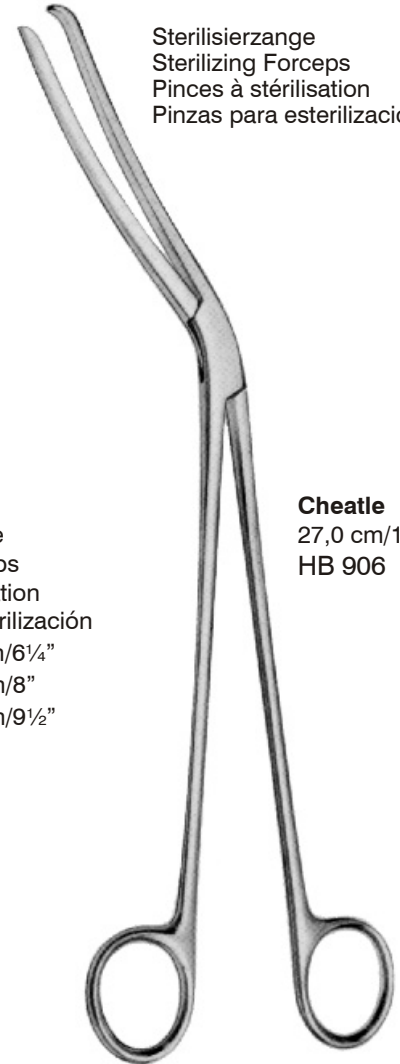

Sterilisierzange
 Sterilizing Forceps
 Pinces à stérilisation
 Pinzas para esterilización

Cheatle
 27,0 cm/10½"
 HB 906

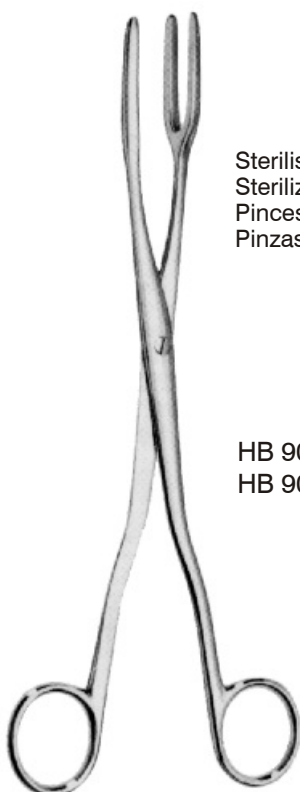

Sterilisierzange
 Sterilizing Forceps
 Pinces à stérilisation
 Pinzas para esterilización

HB 907 20,0 cm/8"
 HB 908 30,0 cm/12"

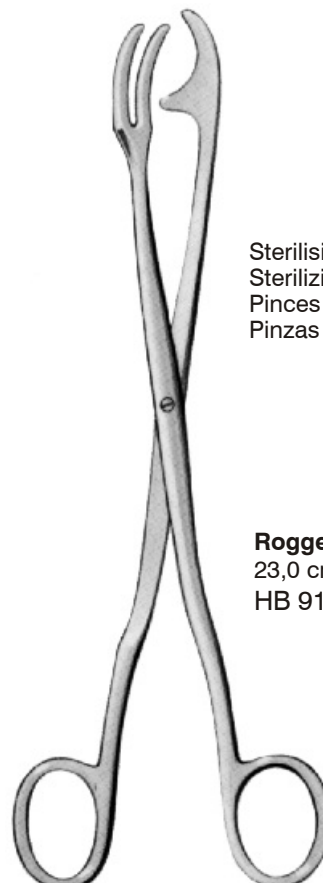

Sterilisierzange
 Sterilizing Forceps
 Pinces à stérilisation
 Pinzas para esterilización

Rogge
 23,0 cm/9"
 HB 910

