

**Neurochirurgie und Laminektomie**  
**Neurosurgery and Laminectomy**  
**Neurochirurgie et Laminectomie**  
**Neurocirugía y Laminectomía**

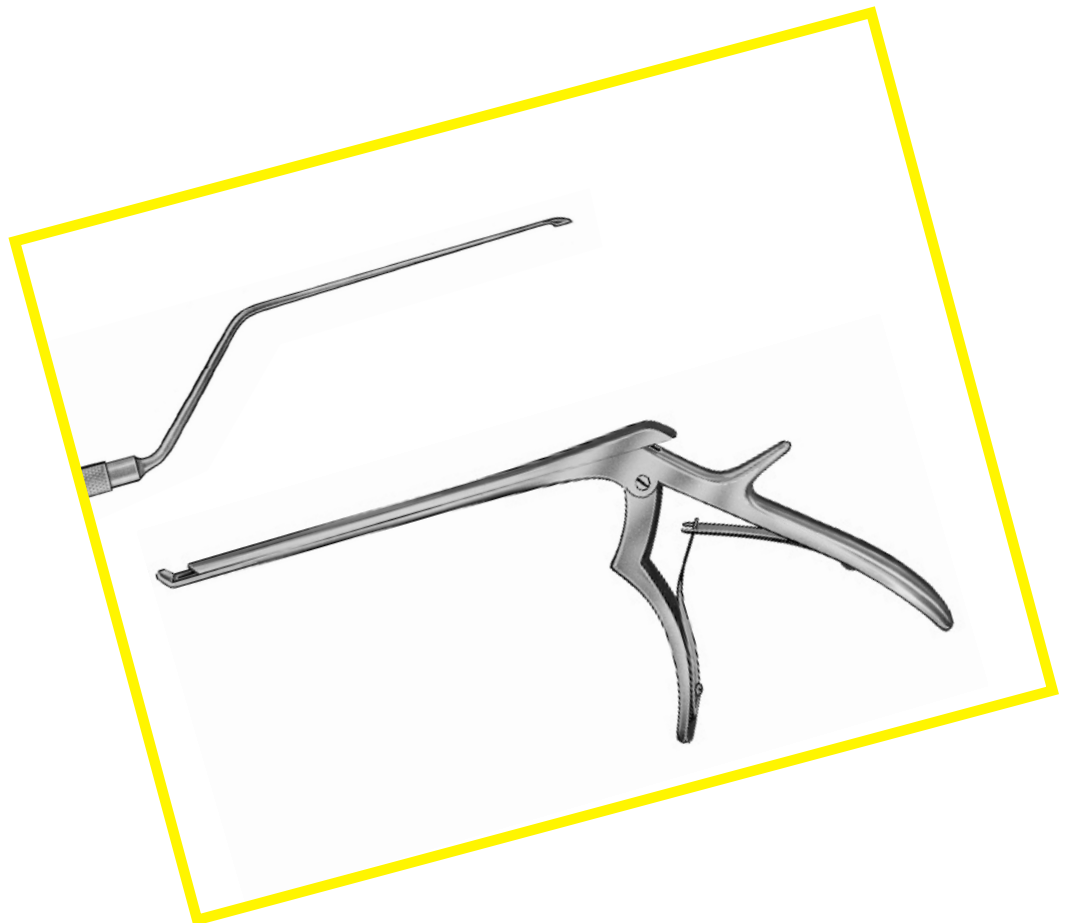

**Instrumente zur Schädelöffnung**  
**Instruments for Cranial Opening**  
**Instrumentos pour l'ouverture du crâne**  
**Instrumentos para abertura craneana**



Drahtsäge  
 Wire Saw  
 Scie en fil  
 Sierra de hilo

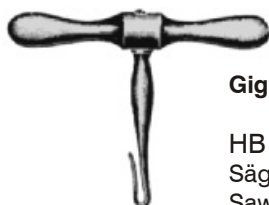
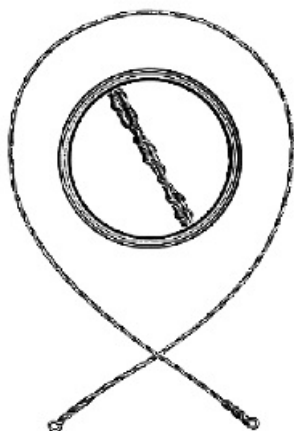

**Gigli**

HB 1323-00  
 Sägegriff  
 Saw handle  
 Manche pour scies  
 Mango para sierras



**Martel**

Einführungsinstrument für Drahtsägen  
 Conductor for wire saws  
 Conducteur pour scies en fil  
 Conductores para sierras de hilo

HB 1324-30 30,0 cm/12"  
 HB 1324-33 33,0 cm/13¼"

**Olivecrona**

2-fach, two-fold, à deux pièces,  
 de dos piezas  
**1,2 mmØ**

HB 1320-30 Fig. 1 30 cm/12"  
 HB 1320-40 Fig. 2 40 cm/16"  
 HB 1320-50 Fig. 3 50 cm/20"  
 HB 1320-60 Fig. 4 60 cm/24"  
 HB 1320-70 Fig. 5 70 cm/28"

**Gigli**

3-fach, three-fold, à trois pièces,  
 de tres piezas  
**1,4 mmØ**

HB 1321-30 Fig. 1 30 cm/12"  
 HB 1321-40 Fig. 2 40 cm/16"  
 HB 1321-50 Fig. 3 50 cm/20"  
**1,8 mmØ**  
 HB 1322-50 Fig. 1 50 cm/20"



**Dahlgren**

HB 1328-20  
 20,0 cm/8"

Schädelzangen  
 Skull-Cutting Forceps  
 Pinces pour le crâne  
 Pinzas para el cráneo



**De Vibiss**

HB 1329-21  
 21,0 cm/8¼"

**Schädelhalter**  
**Cervical Traction Tongs**  
**Pinces de traction crânienne**  
**Pinzas de tracción craneal**



**HB 1340-00**

Schädelhalter für die Extension des Halswirbels, Dorne verstellbar, Vorbohren nicht erforderlich

Cervical Traction Tong, for extension of the neck vertebrae, pins adjustable hence no initial drilling

Pince de traction crânienne, pour l'extension des vertèbres cervicales, madrins réglables supprimant la perforation initiale

Pinza de tracción craneal para la extensión de las vertebrae de cuello, puntas ajustables suprimiendo perforaciones iniciales

**HB 1340-01**

Ersatzdorn, Spare pin only, Pointe de rechange seule, Punta de repuesto suelta



**Crutchfield**

**Fig. 1**

**HB 1341-01**

Schädelhalter  
 Cervical Traction Tong  
 Pince de traction crânienne  
 Pinza de tracción craneal



**Crutchfield**

**Fig. 2**

**HB 1341-02**

Schädelhalter  
 Cervical Traction Tong  
 Pince de traction crânienne  
 Pinza de tracción craneal

Ø 3,5 mm



Ø 5,0 mm



**HB 1341-04**

3,5 mm

**HB 1341-05**

5,0 mm

Vorbohrer für Crutchfield Schädelhalter  
 Drill Point for Crutchfield Cervical Traction Tongs  
 Alésoir pour pince de traction crânienne de Crutchfield  
 Perforador inicial para pinzas de tracción craneal de Crutchfield

**Wirbelkörperspreizer  
Lamina Spreaders  
Ecarteurs pour corps vertébraux  
Separadores para cuerpos vertebrales**



**Cloward**  
HB 1345-16  
16,0 cm/6½"

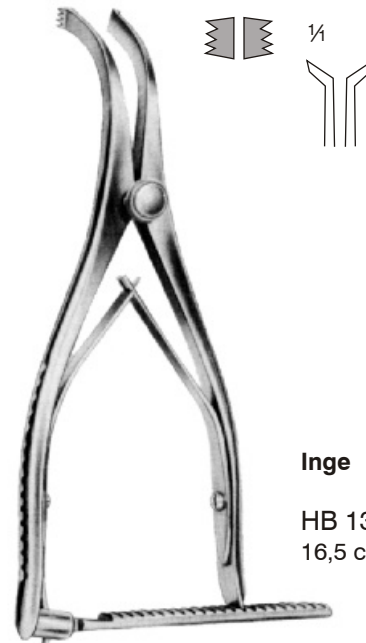

**Inge**  
HB 1345-17  
16,5 cm/6½"

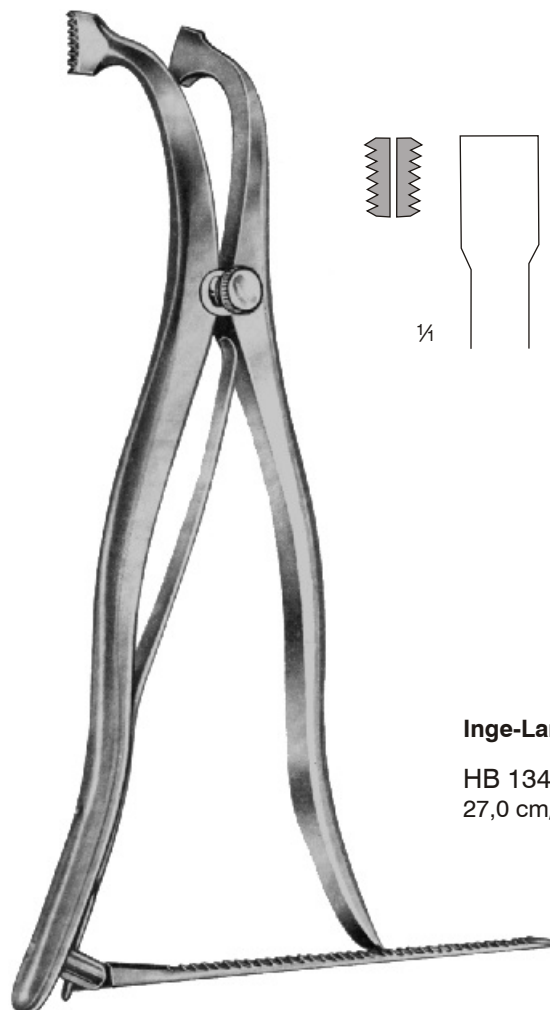

**Inge-Lamina**  
HB 1345-27  
27,0 cm/10¾"

**Klammern**      **Klammer-Anlegezangen**  
**Clips**            **Clip Applying Forceps**  
**Agrafes**          **Pincas pour appliquer des agrafes**  
**Grapas**           **Pinzas para poner grapas**

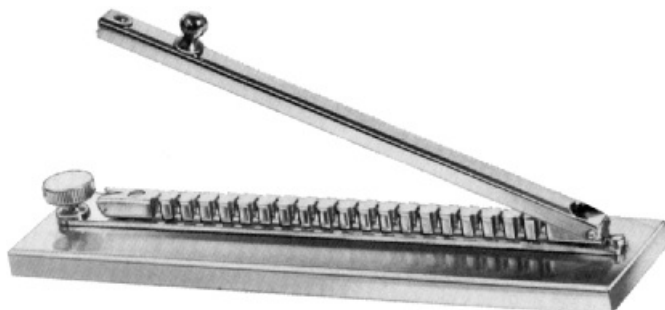

**Mc Kenzie**

**HB 1350-01**  
 Klammernblock mit 1 Klammerbügel  
 Brain Clip Carrier, with 1 clip holding rack  
 Support porte-agraves, avec 1 rangée d'agrafes  
 Porta-grapas, con 1 riel para grapas  
 148 x 40 x 6 mm / 5¾ x 1½ x ¼"



¼

**HB 1351-00**  
 100 Stück Silberklammern in Plastikbehälter  
 100 pieces Silver Brain Clips in plastic case  
 100 pièces agrafes en argent, dans une boîte  
 de plastique  
 100 piezas grapas de plata en tubo de  
 plástico

**HB 1350-02**  
 Klammernblock mit 2 Klammerbügel und  
 Schiebedeckeln  
 Brain Clip Carrier, with 2 clip holding rack and  
 sliding covers  
 Support porte-agraves, avec 2 rangée d'agrafes  
 et couvercle à glissière  
 Porta-grapas, con 2 rieles para grapas y tapas  
 corredizas  
 190 x 48 x 13 mm / 7½ x 2 x ½"



¼

**Raney**

**HB 1353-00**  
 Kopfhautklammer  
 Scalp Hemostasis Clip  
 Clip hémostatique pour  
 le cuir chevelu  
 Clip hemostática para  
 el cuero cabelludo

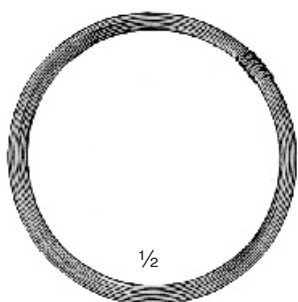

½

**McKenzie**

**HB 1352-00**  
 Silberdraht in Ringen zu 2,5 Gramm  
 Silver Wire in coils of 2,5 g  
 Fil d'argent, par rouleaux de 2,5 g  
 Hilo de plata en rollos de 2,5 g



½

**Raney**

**HB 1354-00**  
 16,0 cm/6½"  
 Anlege- und Abnehmezange für Kopfhaut-klammern  
 Applying and Removing Forceps for Scalp Hemostasis  
 Clips  
 Pince pour appliquer et enlever les clips hémostatiques  
 pour le cuir chevelu  
 Pinza para aplicar y quitar clips hemostáticas para el  
 cuero cabelludo

**Klammer-Anlegezangen**  
**Clip Applying Forceps**  
**Pinces pour appliquer des agrafes**  
**Pinzas para poner grapas**

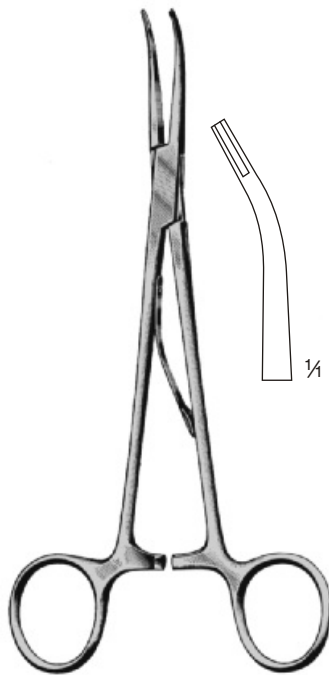

Klammer-Anlegezangen,  
gebogen  
Clip Applying Forceps,  
curved  
Pinces pour appliquer des  
agrafes, courbes  
Pinzas para poner grapas,  
curvas

**McKenzie**

HB 1360-15 15,0 cm/6"  
 HB 1360-19 19,0 cm/7½"

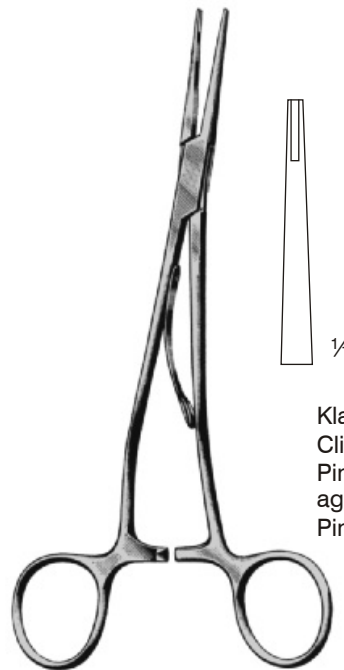

Klammer-Anlegezangen, gerade  
 Clip Applying Forceps, straight  
 Pinces pour appliquer des  
 agrafes, droits  
 Pinzas para poner grapas, rectas

**McKenzie**

HB 1361-15 15,0 cm/6"  
 HB 1361-19 19,0 cm/7½"

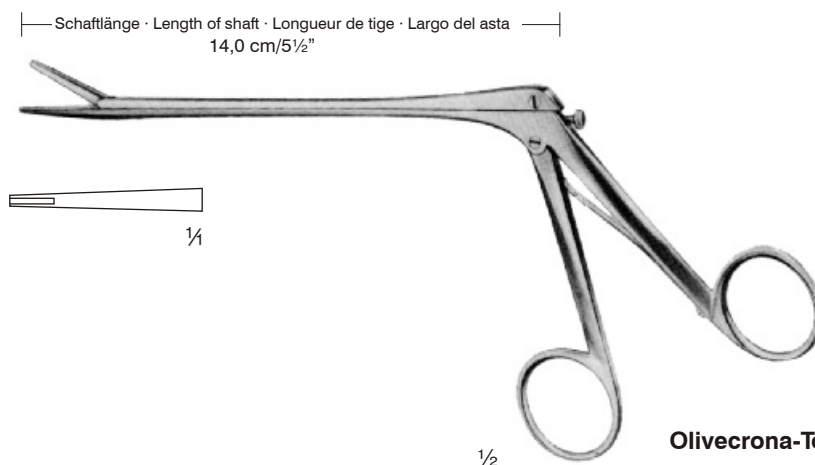

**Olivecrona-Toennis**

HB 1362-14  
 14,0 cm/5½"

Klammer-Anlegezange  
 Clip Applying Forceps  
 Pince pour appliquer des agrafes  
 Pinza para poner grapa

**Hirnspatel**  
**Brain Spatulas**  
**Spatules cérébrales**  
**Espátulas cerebrales**



**Cushing**  
 18,0 cm/7"

	mm
HB 1364-01	7/ 9
HB 1364-02	11/13
HB 1364-03	15/18
HB 1364-04	18/22



**Heifetz**  
 biegsam, malleable  
 malléable, maleable  
 20,0 cm/8"

	mm
HB 1365-08	8
HB 1365-11	11
HB 1365-14	14
HB 1365-17	17
HB 1365-20	20

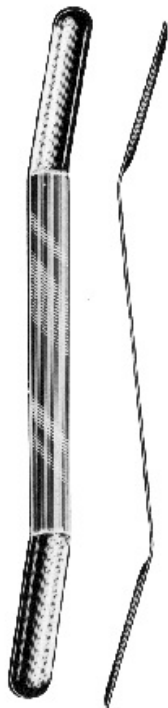

**Olivecrona**  
 18,0 cm/7"

Spatelbreite, mm  
 Width of spatulas, mm  
 Largeur de spatule, mm  
 Anchura de espátulas, mm

konkav  
 concave  
 concave  
 cóncava

oben  
 upper end  
 en haut  
 arriba

unten  
 lower end  
 en bas  
 abajo

konvex  
 convex  
 convex  
 convexa

HB 1366-01	7	9	HB 1367-01
HB 1366-02	11	13	HB 1367-02
HB 1366-03	15	18	HB 1367-03
HB 1366-04	18	22	HB 1367-04

Explorations- und Koagulationshäkchen  
Exploration- and Coagulation Hooks  
Crochets d'exploration y coagulation  
Ganchos para exploración y coagulación



1/4



Fig. 1  
HB 1369-01



Fig. 2  
HB 1369-02



Fig. 3  
HB 1369-03



Fig. 4  
HB 1369-04

**Caspar**  
24,5 cm/9<sup>3</sup>/<sub>4</sub>"

geknöpft, isoliert  
probe-end, insulated  
boutonné, isolé  
abotonado, aislado



Fadenführer  
Ligature Guides  
Passe-fils  
Guía-ligaduras

Nerv- und Gefäßhäkchen  
Nerve- and Vessel Hooks  
Crochets à nerfs et à vaisseaux  
Ganchos para nervios y vasos



**Yasargil**

**Fig. 1**  
HB 1370-01  
18,5 cm/7¼"  
Fadenführer, geknöpft  
Ligature Guide, probe pointed  
Passe-fil, boutonné  
Guía-ligadura, abotonado

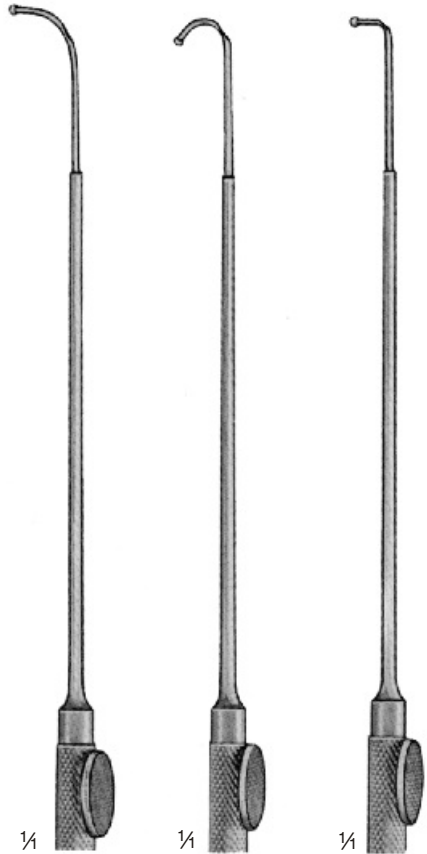

**Fig. 2** HB 1370-02  
**Fig. 3** HB 1370-03  
**Fig. 4** HB 1370-04

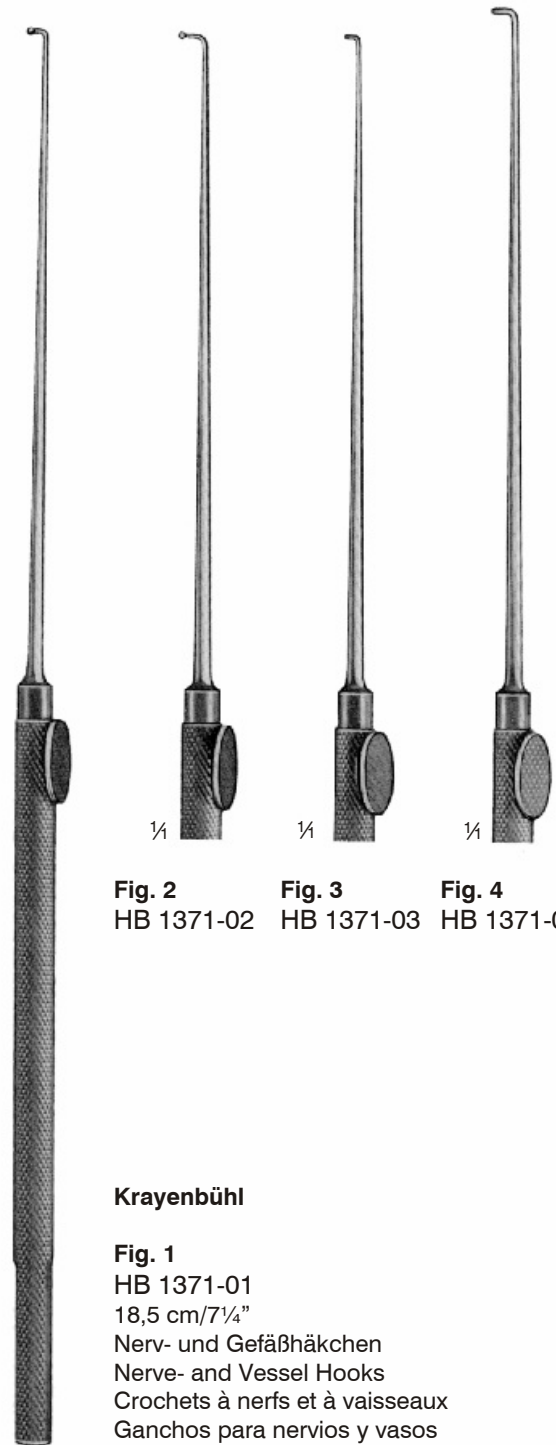

**Krayenbühl**

**Fig. 1**  
HB 1371-01  
18,5 cm/7¼"  
Nerv- und Gefäßhäkchen  
Nerve- and Vessel Hooks  
Crochets à nerfs et à vaisseaux  
Ganchos para nervios y vasos

**Fig. 2** HB 1371-02  
**Fig. 3** HB 1371-03  
**Fig. 4** HB 1371-04

**Mikro-Häkchen**      **Mikro-Raspatorien**  
**Micro Hooks**        **Micro Raspatories**  
**Micro-Crochets**      **Micro-Rugines**  
**Micro-Ganchitos**    **Micro-Periostótomos**



HB 1372-19  
18,5 cm/7¼"

Durahäkchen  
 Dura Hook  
 Crochet pour la dure-mère  
 Ganchito para dura-madre



**Fisch**  
 HB 1373-19  
 18,5 cm/7¼"

Feines Häkchen  
 Delicate Hook  
 Crochet fin  
 Ganchito muy fino



**Yasargil**  
 18,5 cm/7¼"

Mikro-Raspator  
 Micro-raspatory  
 Micro-rugine  
 Micro-periostótomo



**Fig. 1**  
 HB 1374-01

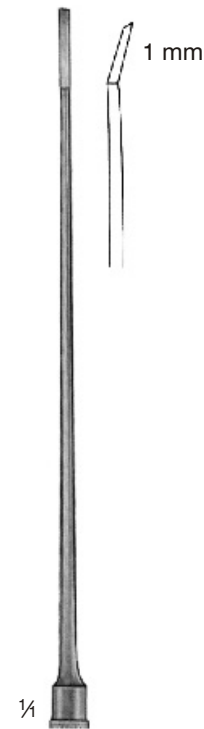

**Fig. 2**  
 HB 1374-02

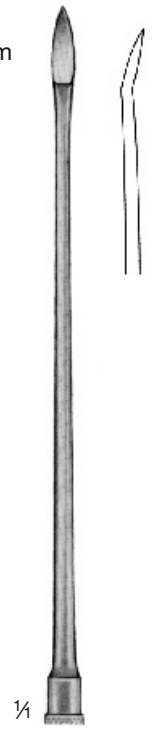

**Fig. 3**  
 HB 1374-03

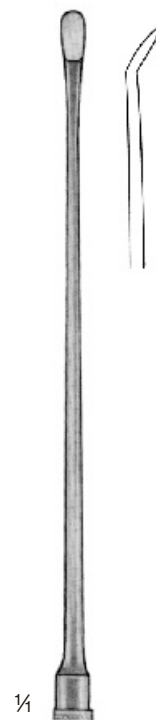

**Fig. 4**  
 HB 1374-04

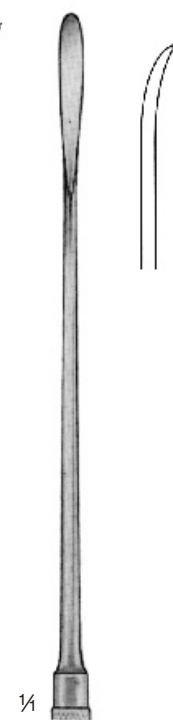

**Fig. 5**  
 HB 1374-05

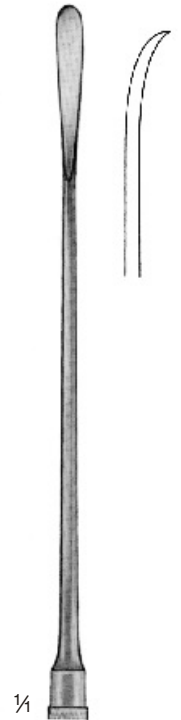

**Fig. 6**  
 HB 1374-06

**Mikro-Löffel**  
**Micro Scoops**  
**Micro-Curettes**  
**Micro-Cucharillas**

**Mikro-Gabeln**  
**Micro Forks**  
**Micro-Fourches**  
**Micro-Empujadores**

**Mikro-Raspatorien**  
**Micro Raspatories**  
**Micro-Rugines**  
**Micro-Periostótomos**



**Yasargil**  
 18,5 cm/7¼"  
 Fadengabel  
 Suture pusher  
 Fourche à fil  
 Empujador de sutura

**Fig. 1**  
 HB 1375-01

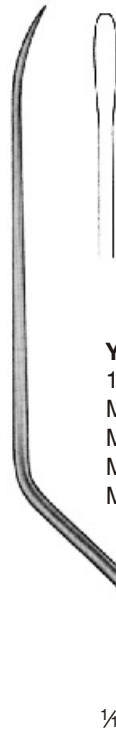

**Yasargil**  
 18,5 cm/7¼"  
 Mikro-Raspatorien  
 Micro-raspatories  
 Micro-rugines  
 Micro-periostótomos

**Fig. 2**  
 HB 1375-02

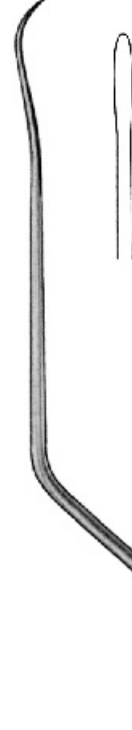

**Fig. 3**  
 HB 1375-03

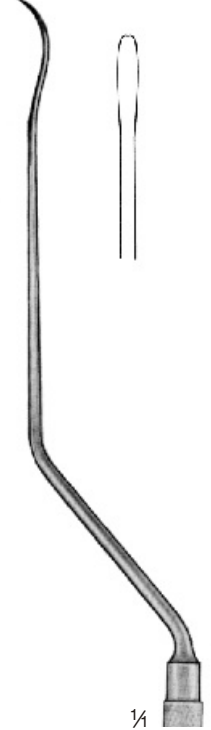

**Fig. 4**  
 HB 1375-04



**Yasargil**  
 18,5 cm/7¼"  
 Scharfer Löffel  
 Scoop, bayonet-shaped  
 Curette tranchante  
 Cucharilla cortante

HB 1376-19



**Jakobson**  
 18,5 cm/7¼"  
 Doppelsonde  
 Twin Probe  
 Sonde double  
 Sonda doble

HB 1377-19



**Jacobson**  
 18,5 cm/7¼"  
 Knopfsonde  
 Buttoned Probe  
 Sonde boutonnée  
 Sonda abotonada

HB 1378-19



**Jacobson**  
 HB 1379-19  
 18,5 cm/7¼"

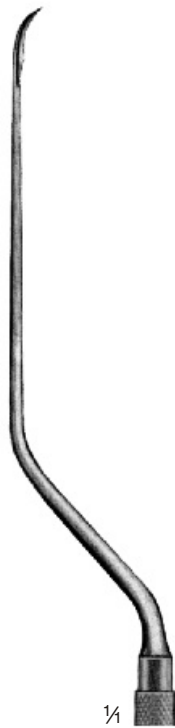

**Koos**  
**Fig. 1**  
 HB 1380-01  
 18,5 cm/7¼"



**Koos**  
**Fig. 2**  
 HB 1380-02  
 18,5 cm/7¼"



**Koos**  
**Fig. 3**  
 HB 1380-03  
 18,5 cm/7¼"

Schneide seitlich  
 Lateral cutting edge  
 Tranchant latéral  
 Filo de corte lateral

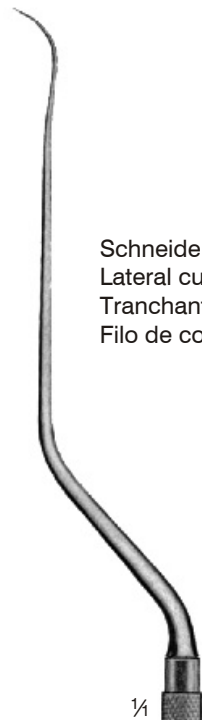

**Kraus**  
 HB 1381-19  
 18,5 cm/7¼"

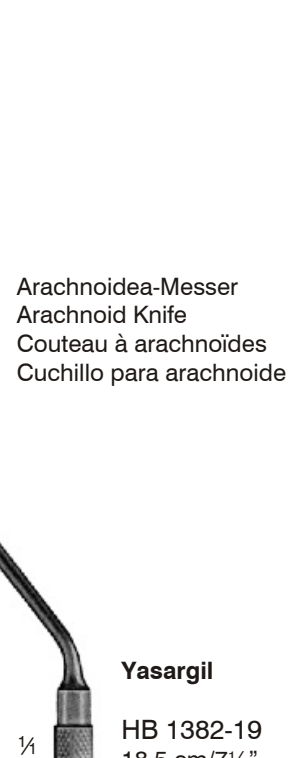

**Yasargil**  
 HB 1382-19  
 18,5 cm/7¼"

Arachnoidea-Messer  
 Arachnoid Knife  
 Couteau à arachnoïdes  
 Cuchillo para arachnoide

Galeahaken  
 Galea Hooks  
 Crochets de galeati  
 Gancho para galea

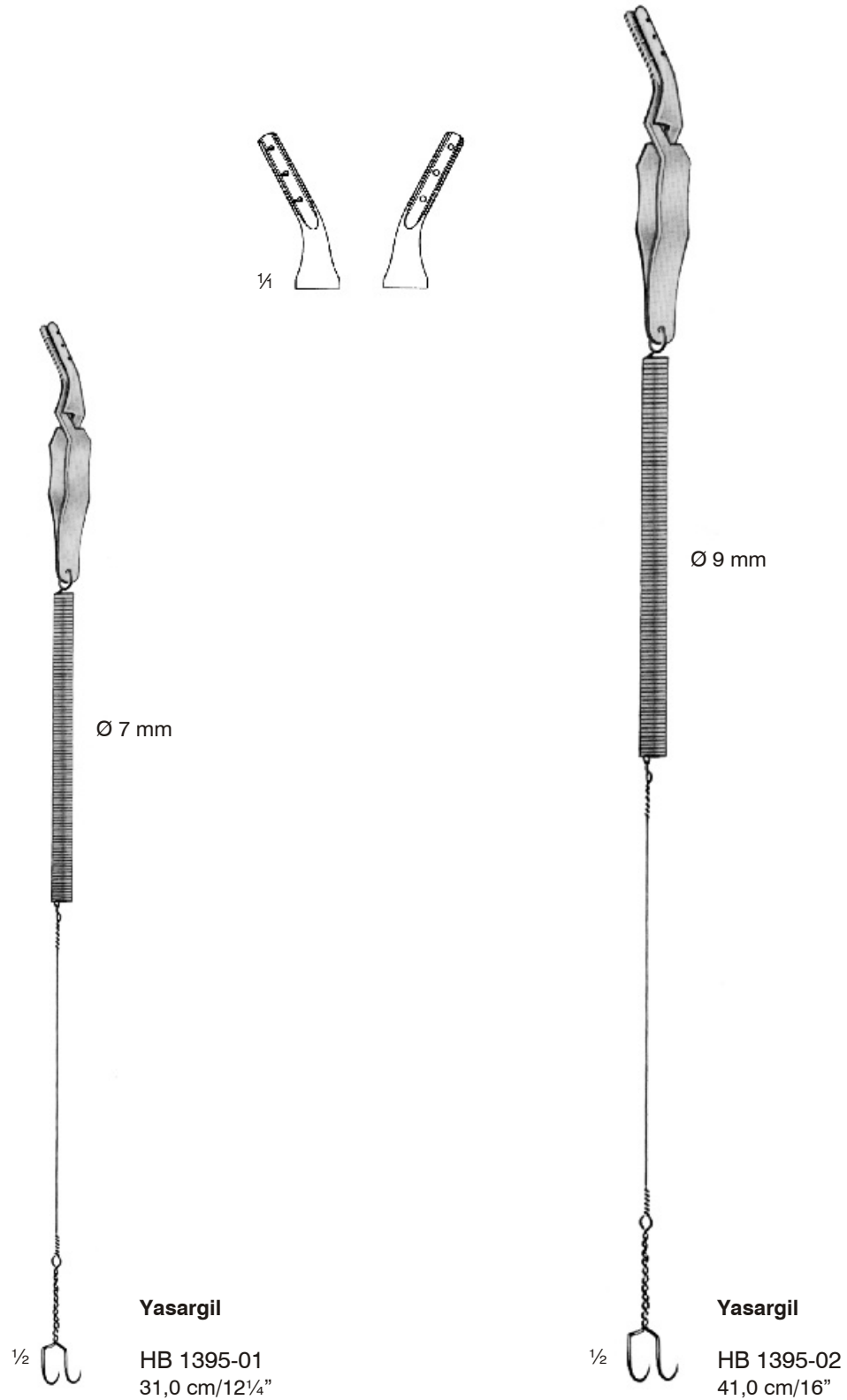

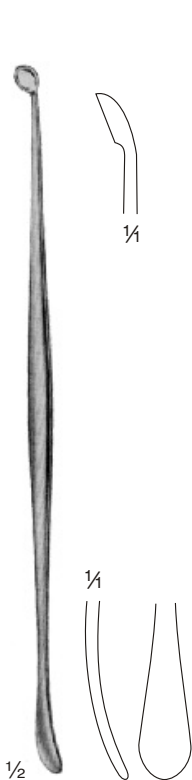

**Penfield**

**Fig. 1**  
 HB 1401-01  
 18,0 cm/7"

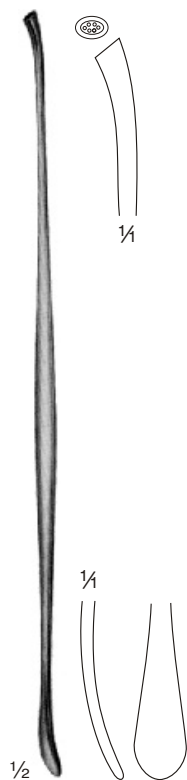

**Penfield**

**Fig. 2**  
 HB 1401-02  
 20,0 cm/8"

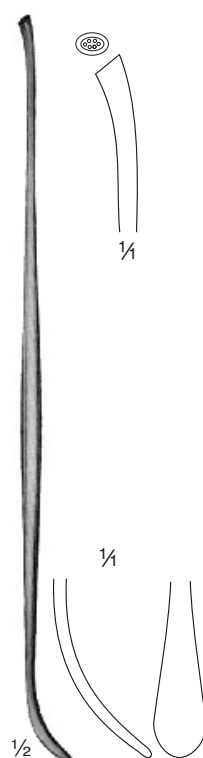

**Penfield**

**Fig. 3**  
 HB 1401-03  
 20,0 cm/8"



**Penfield**

**Fig. 4**  
 HB 1401-04  
 21,5 cm/8½"



**Penfield**

**Fig. 5**  
 HB 1401-05  
 29,0 cm/11½"

**Dura-Dissektoren**  
**Dura Dissectors**  
**Dissecteurs à dure-mère**  
**Disecadores para dura-madre**

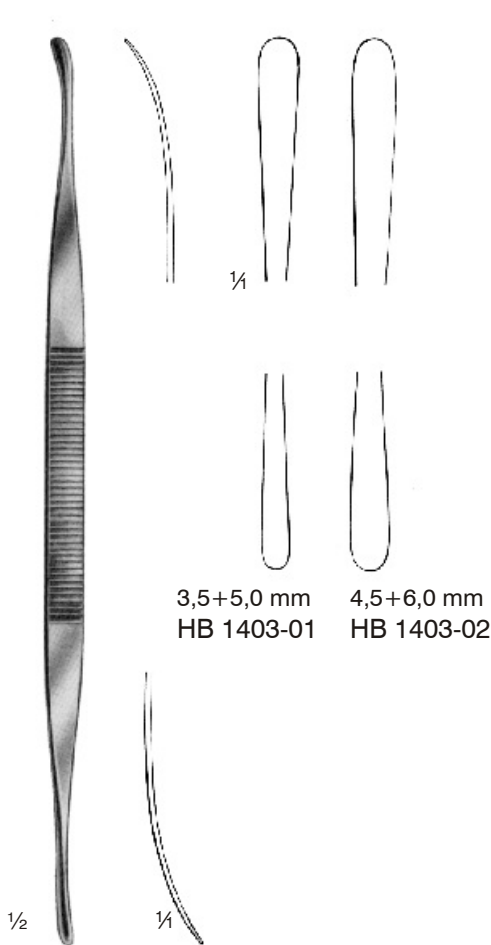

**Toennis**  
 24,0 cm/9½"

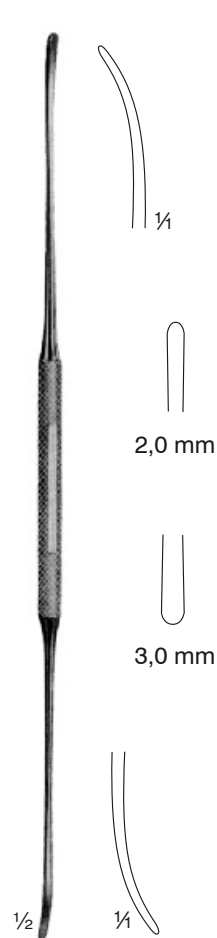

**Olivecrona**  
 2 + 3 mm  
 HB 1404-01 18,0 cm/7"  
 HB 1404-02 24,0 cm/9½"

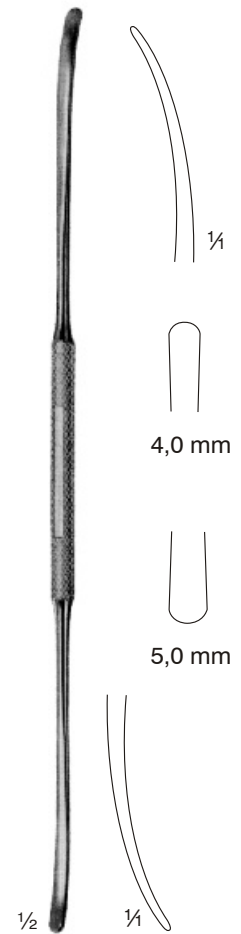

**Olivecrona**  
 4 + 5 mm  
 HB 1404-03 18,0 cm/7"  
 HB 1404-04 24,0 cm/9½"

**Dura-Dissektoren**  
**Dura Dissectors**  
**Dissecteurs pour la dure-mère**  
**Disecadores para dura-madre**

**Dura-Separatoren**  
**Dura Dissectors**  
**Dissecteurs pour la dure-mère**  
**Descoladores de dura-madre**

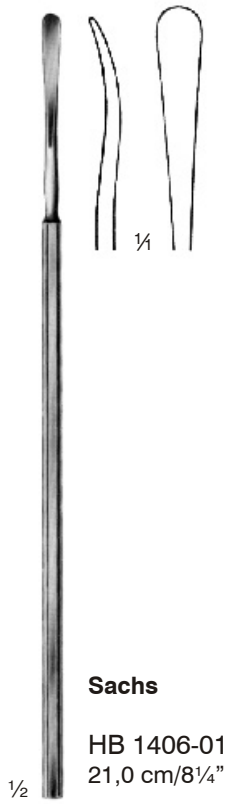

**Sachs**

HB 1406-01  
 21,0 cm/8¼"



**Sachs**

HB 1406-02  
 21,0 cm/8¼"

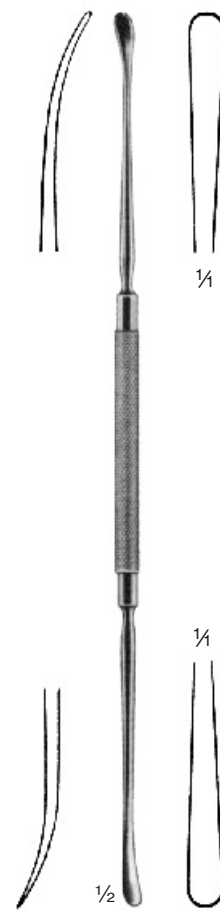

**Davis**  
 4 mm

HB 1407-24  
 24,5 cm/9¾"

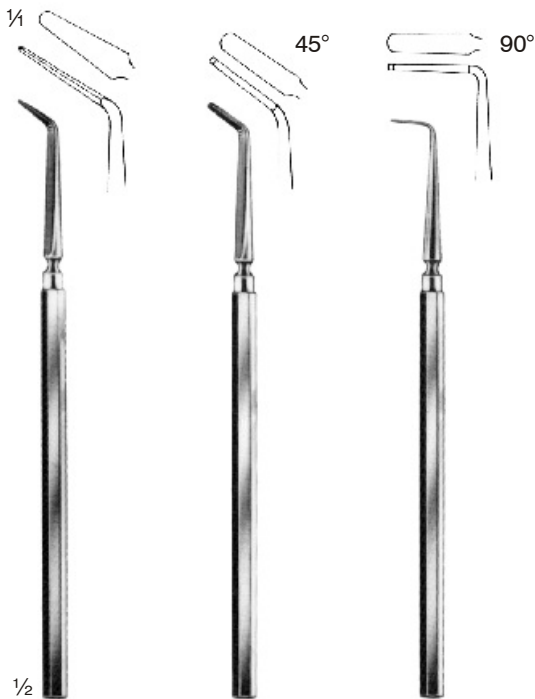

**Frazier**

HB 1410-01  
 15,0 cm/6"

**Hoen**

HB 1410-02  
 15,0 cm/6"

**Hoen**

HB 1410-03  
 15,0 cm/6"

**Dura-Separatoren**  
**Dura Dissectors**  
**Dissecteurs pour la dure-mère**  
**Descoladores de dura-madre**



**Nervwurzelnhaken**  
**Nerve Root Retractors**  
**Retracteurs pour racines nerveuses**  
**Separadores de raíz de nervios**

**Dura-Separatoren**  
**Dura Dissectors**  
**Dissecteurs pour la dure-mère**  
**Descoladores de dura-madre**

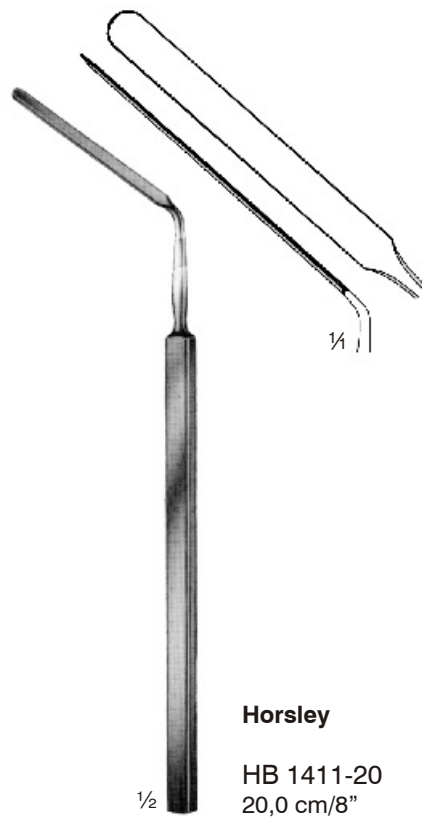

Dura Separator  
 Dura Dissector  
 Dissecteur pour la dure-mère  
 Descolorador de dura-madre

**Horsley**

HB 1411-20  
 20,0 cm/8"

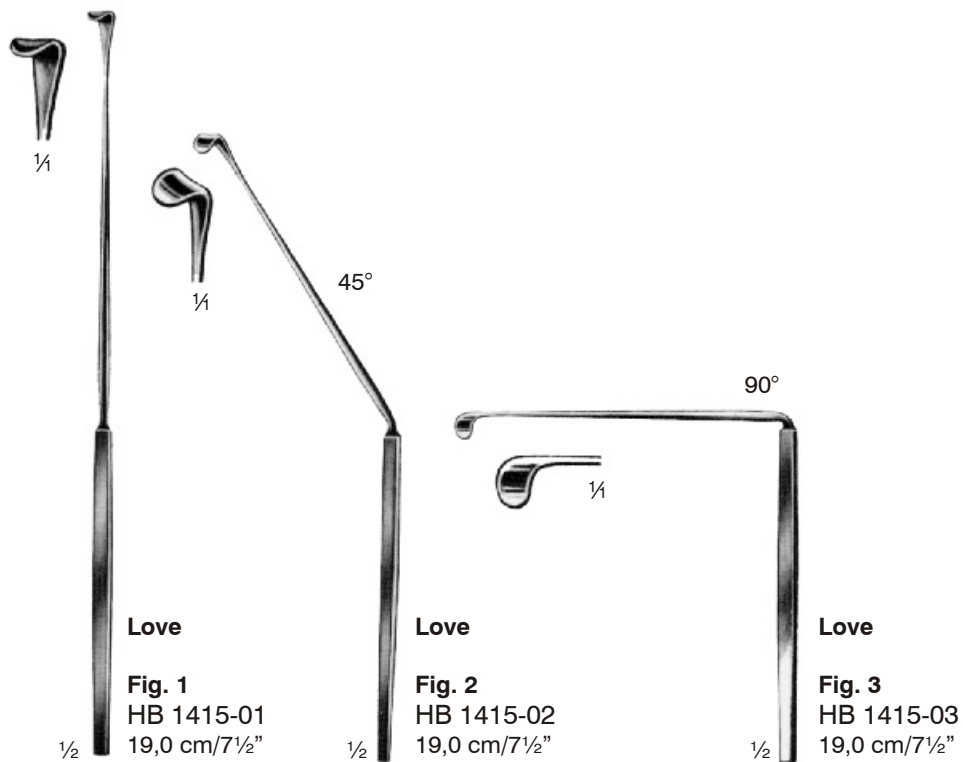

**Love**

**Fig. 1**  
 HB 1415-01  
 19,0 cm/7½"

**Love**

**Fig. 2**  
 HB 1415-02  
 19,0 cm/7½"

**Love**

**Fig. 3**  
 HB 1415-03  
 19,0 cm/7½"

**Nervwurzelhaken**  
**Nerve Root Retractors**  
**Retracteurs pour racines nerveuses**  
**Separadores de raíz de nervios**



**Scoville**

HB 1416-01  
 23,0 cm/9"  
 gerade, straight  
 droit, recto

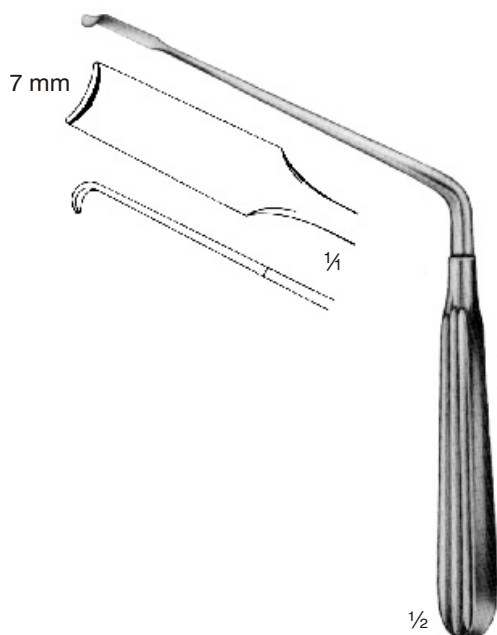

**Scoville**

HB 1416-02  
 20,0 cm/8"  
 abgewinkelt, angular  
 coudé, angular

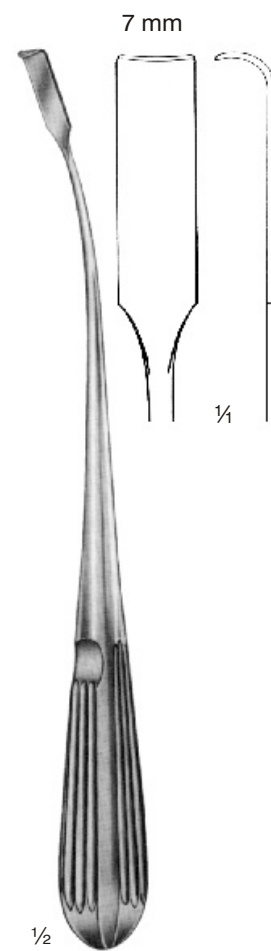

**Holsher**

HB 1417-24  
 24,0 cm/9½"

**Nervhaken**  
**Nerve Hooks**  
**Crochets à nerfs**  
**Ganchos para nervios**

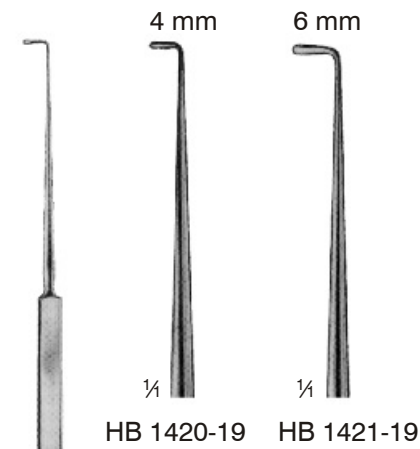

HB 1420-19 HB 1421-19

**Cushing**

HB 1420-19 19,0 cm/7½"  
 HB 1421-19 19,0 cm/7½"

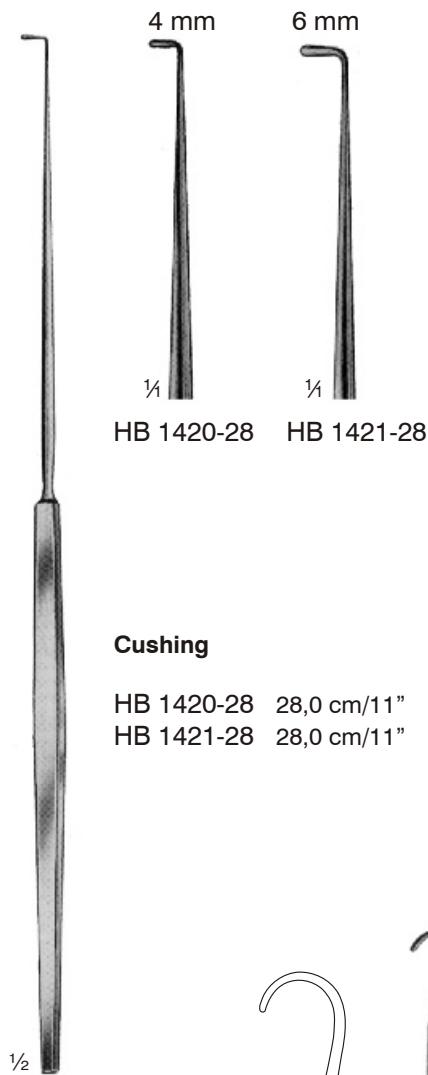

HB 1420-28 HB 1421-28

**Cushing**

HB 1420-28 28,0 cm/11"  
 HB 1421-28 28,0 cm/11"

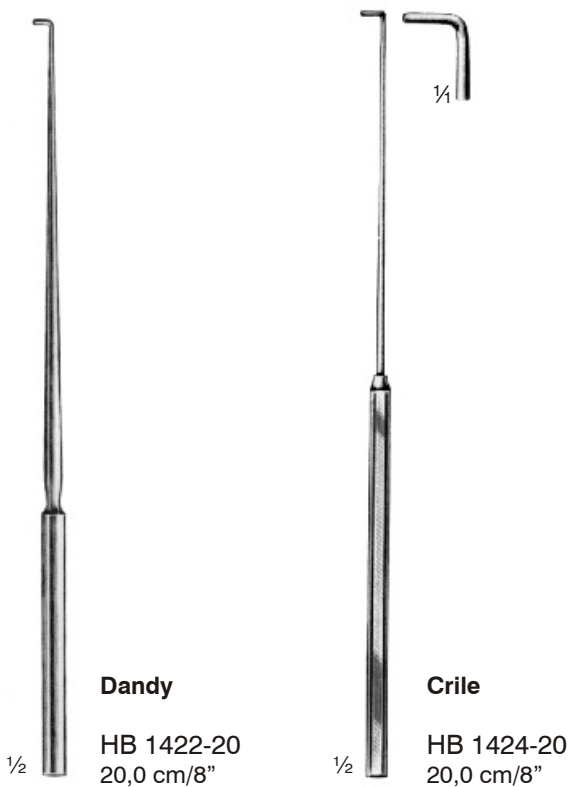

**Dandy**  
 HB 1422-20  
 20,0 cm/8"

**Crile**  
 HB 1424-20  
 20,0 cm/8"

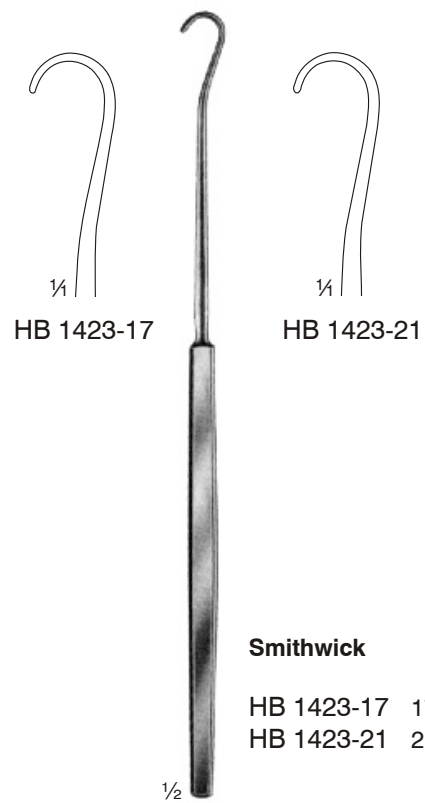

HB 1423-17

HB 1423-21

**Smithwick**

HB 1423-17 17,0 cm/6½"  
 HB 1423-21 21,0 cm/8¼"

**Dura- und Nervhaken**  
**Dura and Nerve Hooks**  
**Crochets à dure-mère et à nerfs**  
**Ganchos para dura madre y nervios**

**Duramesser**  
**Dura Knives**  
**Bistouris à dure-mère**  
**Bisturías para dura madre**



**Adson**  
 spitz, sharp  
 pointu, agudo

HB 1425-01  
 20,0 cm/8"



**Adson**  
 stumpf, blunt  
 mousse, romo

HB 1425-02  
 20,0 cm/8"



**Frazier**  
 spitz, sharp  
 pointu, agudo

HB 1426-13 13,0 cm/5"  
 HB 1426-18 18,0 cm/7"

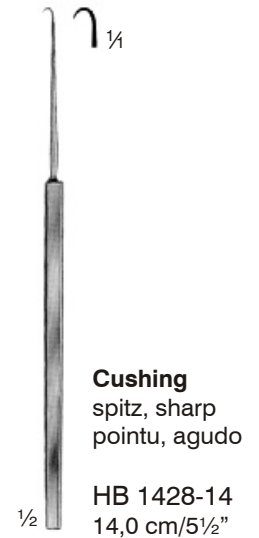

**Cushing**  
 spitz, sharp  
 pointu, agudo

HB 1428-14  
 14,0 cm/5 1/2"

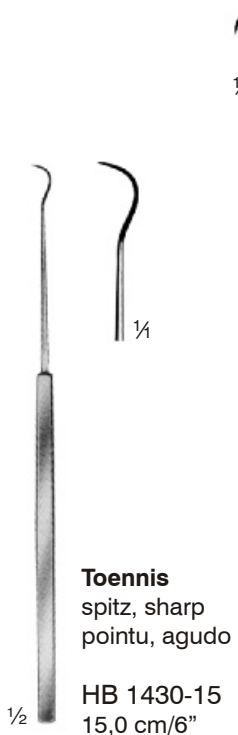

**Toennis**  
 spitz, sharp  
 pointu, agudo

HB 1430-15  
 15,0 cm/6"

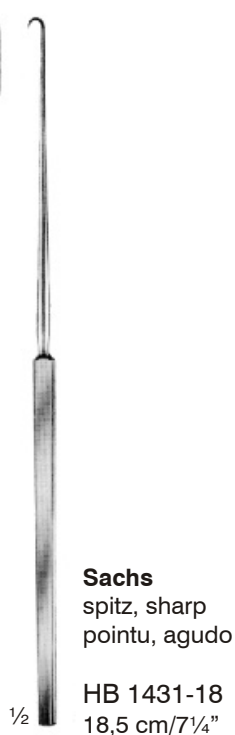

**Sachs**  
 spitz, sharp  
 pointu, agudo

HB 1431-18  
 18,5 cm/7 1/4"



**Graham**  
 stumpf, blunt  
 mousse, romo

HB 1432-16  
 16,5 cm/6 1/2"

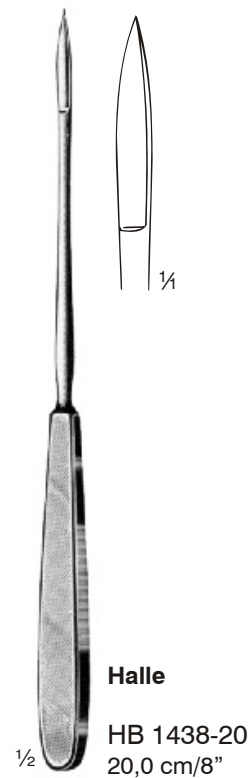

**Halle**

HB 1438-20  
 20,0 cm/8"

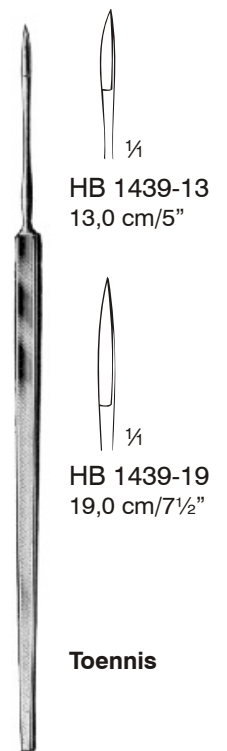

HB 1439-13  
 13,0 cm/5"

HB 1439-19  
 19,0 cm/7 1/2"

**Toennis**

**Bandscheiben-Rongeurs**  
**Intervertebral Disc Rongeurs**  
**Pinces à disques vertébrales**  
**Pinzas para discos vertebrales**

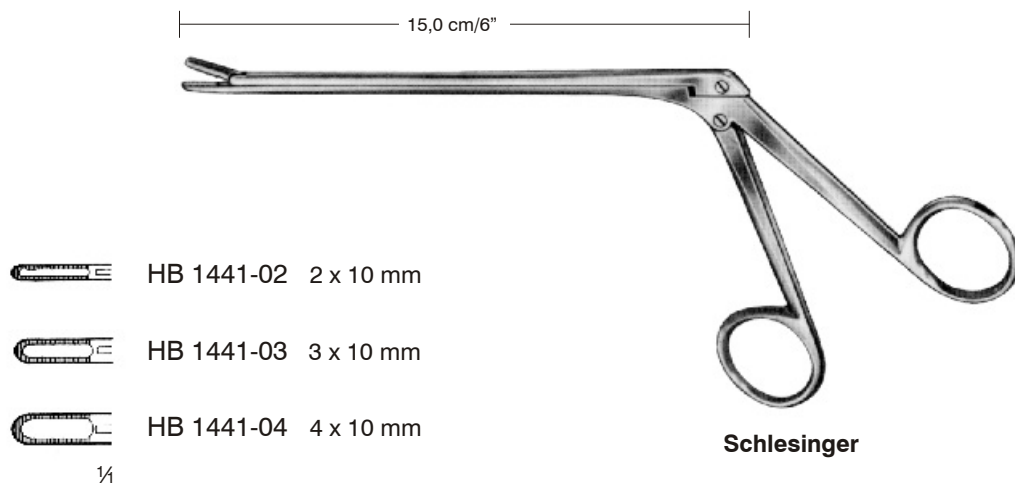
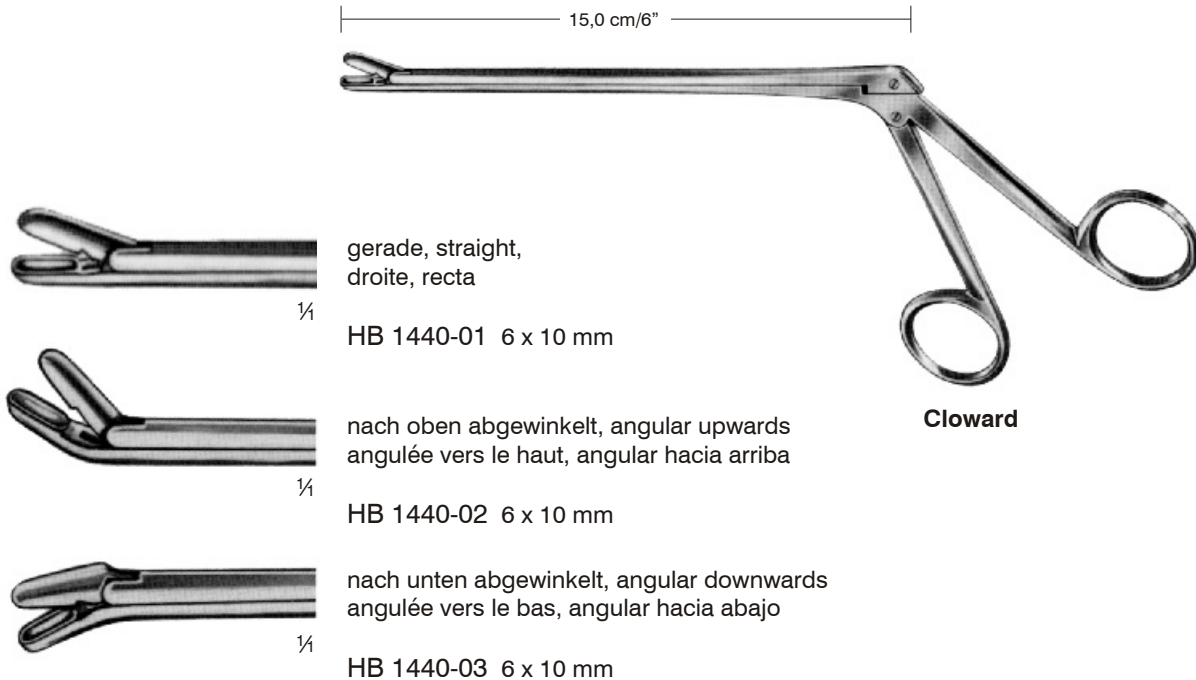

**Laminektomie-Zangen**  
**Laminectomy Rongeurs**  
**Pinces emporte-pièces à laminectomie**  
**Pinzas cortantes para laminectomia**

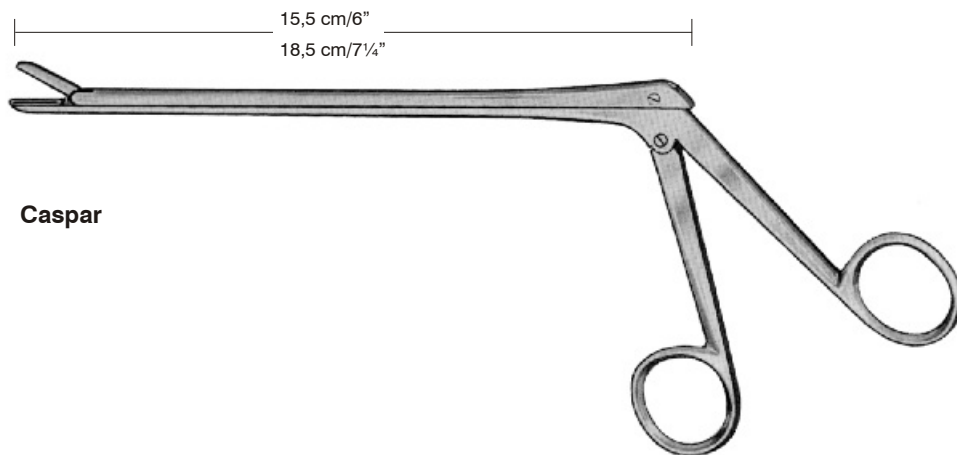

**Caspar**



	 2 x 12 mm	 3 x 12 mm	 4 x 14 mm
15,5 cm/6"	HB 1442-02	HB 1442-03	HB 1442-04
18,5 cm/7 1/4"	HB 1443-02	HB 1443-03	HB 1443-04



	 2 x 12 mm	 3 x 12 mm	 4 x 14 mm
15,5 cm/6"	HB 1444-02	HB 1444-03	HB 1444-04
18,5 cm/7 1/4"	HB 1445-02	HB 1445-03	HB 1445-04



	 2 x 12 mm	 3 x 12 mm	 4 x 14 mm
15,5 cm/6"	HB 1446-02	HB 1446-03	HB 1446-04
18,5 cm/7 1/4"	HB 1447-02	HB 1447-03	HB 1447-04

**Bandscheiben-Rongeure**  
**Intervertebral Disc Rongeurs**  
**Pinces à disques vertébrales**  
**Pinzas para discos vertebrales**

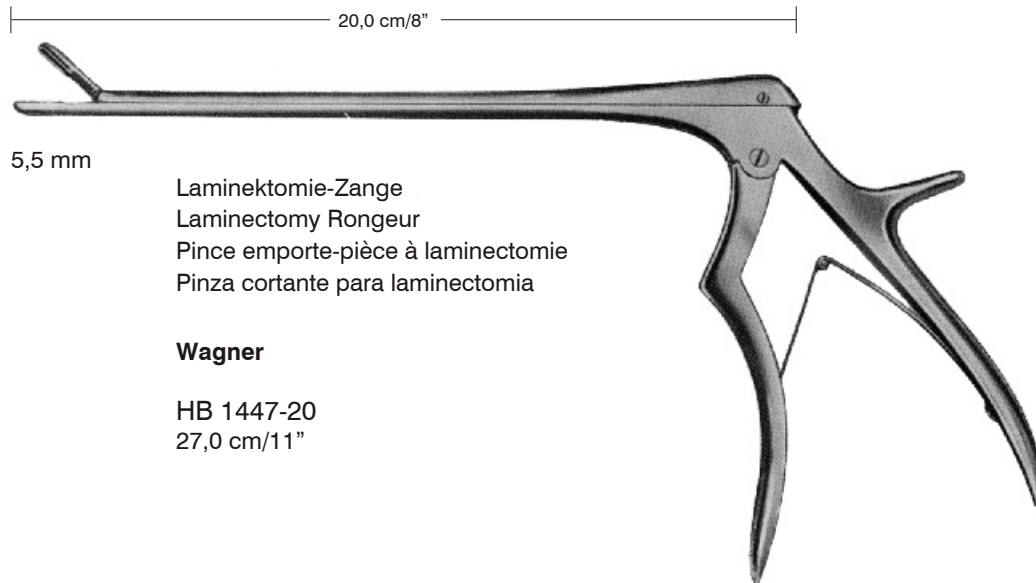

5,5 mm

Laminektomie-Zange  
 Laminectomy Rongeur  
 Pince emporte-pièce à laminectomie  
 Pinza cortante para laminectomia

**Wagner**

HB 1447-20  
 27,0 cm/11"

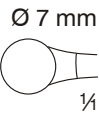
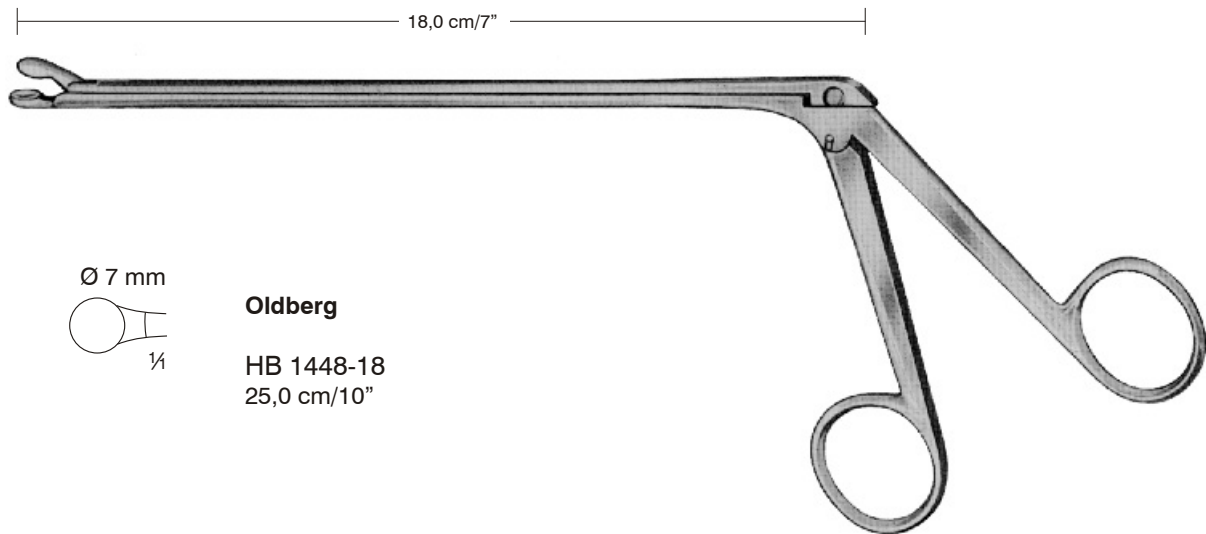

**Oldberg**

HB 1448-18  
 25,0 cm/10"

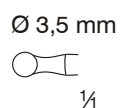
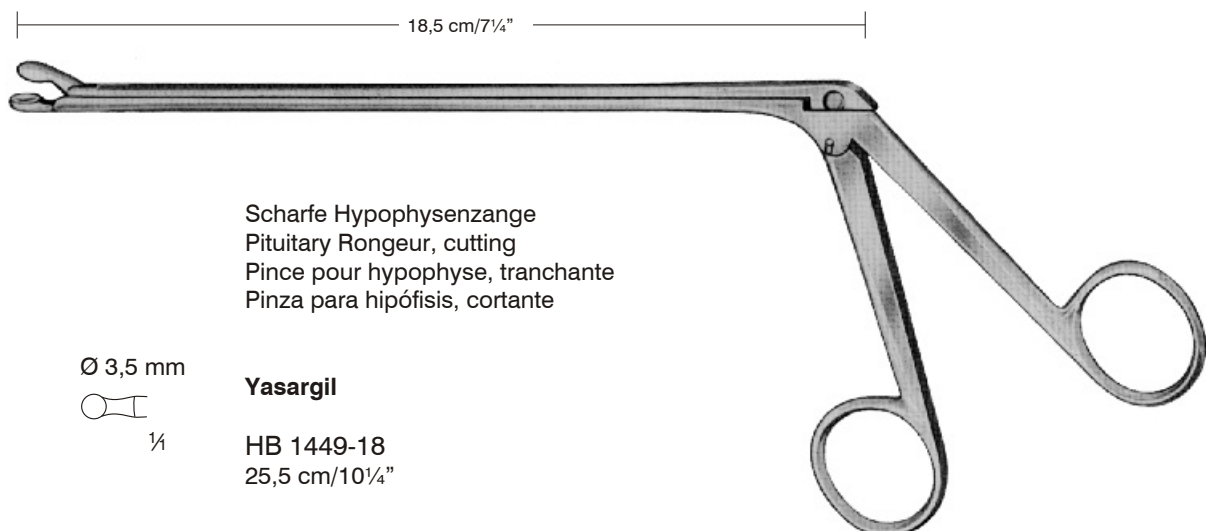

Scharfe Hypophysenzange  
 Pituitary Rongeur, cutting  
 Pince pour hypophyse, tranchante  
 Pinza para hipófisis, cortante

**Yasargil**

HB 1449-18  
 25,5 cm/10 1/4"

**Bandscheiben-Rongeur**  
**Intervertebral Disc Rongeurs**  
**Pinces à disques vertébrales**  
**Pinzas para discos vertebrales**

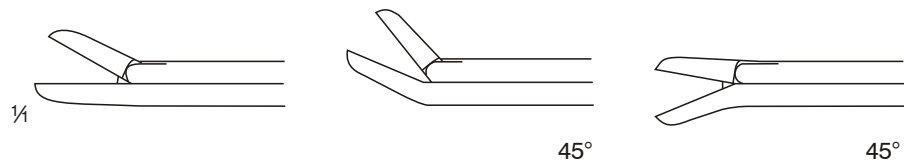
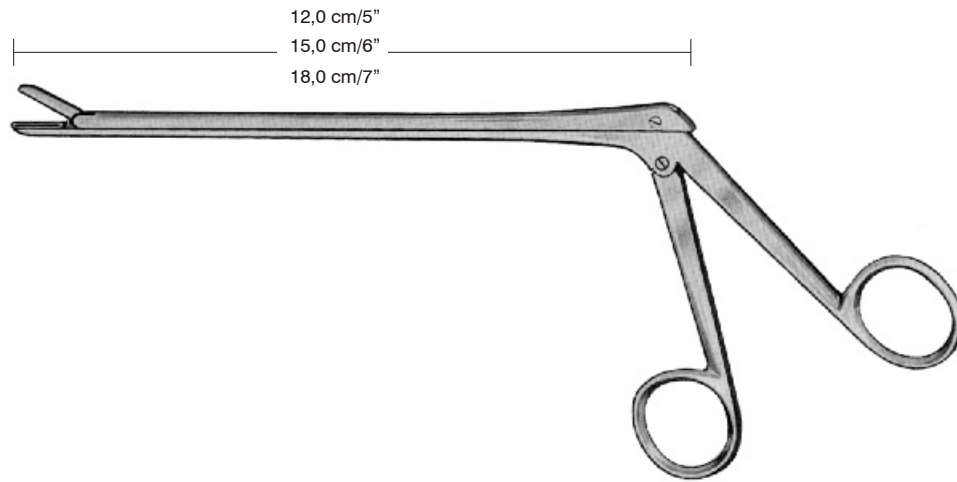

**Cushing**  
**2 x 10mm**

12,0 cm/5"	HB 1450-12	HB 1451-12	HB 1452-12
15,0 cm/6"	HB 1450-15	HB 1451-15	HB 1452-15
18,0 cm/7"	HB 1450-18	HB 1451-18	HB 1452-18

**Love-Gruenwald**  
**3 x 10mm**

12,0 cm/5"	HB 1460-12	HB 1461-12	HB 1462-12
15,0 cm/6"	HB 1460-15	HB 1461-15	HB 1462-15
18,0 cm/7"	HB 1460-18	HB 1461-18	HB 1462-18

**Spurling**  
**4 x 10mm**

12,0 cm/5"	HB 1470-12	HB 1471-12	HB 1472-12
15,0 cm/6"	HB 1470-15	HB 1471-15	HB 1472-15
18,0 cm/7"	HB 1470-18	HB 1471-18	HB 1472-18



**Bandscheiben-Rongeure**  
**Intervertebral Disc Rongeurs**  
**Pinces à disques vertébrales**  
**Pinzas para discos vertebrales**



**Ferris-Smith-Kerrison**

		Bißbreite Width of bite Grandeur de coupe Ancho de la boca	reguläres Modell regular pattern modèle regulier modelo regular		zerlegbares Model dismantable pattern modèle démontable modelo desmontable	
			Schaftlänge , Length of shaft Longueur de tige, Largo del asta	Schaftlänge , Length of shaft Longueur de tige, Largo del asta	Schaftlänge , Length of shaft Longueur de tige, Largo del asta	Schaftlänge , Length of shaft Longueur de tige, Largo del asta
90° nach oben schneidend 90° upwards cutting coupante vers le haut 90° cortante hacia arriba 90°			18,0 cm/7"	20,0 cm/8"	18,0 cm/7"	20,0 cm/8"
¼		1 mm	HB 1480-01	HB 1481-01	HB 1486-01	HB 1487-01
		2 mm	HB 1480-02	HB 1481-02	HB 1486-02	HB 1487-02
		3 mm	HB 1480-03	HB 1481-03	HB 1486-03	HB 1487-03
		4 mm	HB 1480-04	HB 1481-04	HB 1486-04	HB 1487-04
		5 mm	HB 1480-05	HB 1481-05	HB 1486-05	HB 1487-05
		6 mm	HB 1480-06	HB 1481-06	HB 1486-06	HB 1487-06

		Bißbreite Width of bite Grandeur de coupe Ancho de la boca	reguläres Modell regular pattern modèle regulier modelo regular		zerlegbares Model dismantable pattern modèle démontable modelo desmontable	
			Schaftlänge , Length of shaft Longueur de tige, Largo del asta	Schaftlänge , Length of shaft Longueur de tige, Largo del asta	Schaftlänge , Length of shaft Longueur de tige, Largo del asta	Schaftlänge , Length of shaft Longueur de tige, Largo del asta
40° nach oben schneidend 40° upwards cutting coupante vers le haut 40° cortante hacia arriba 40°			18,0 cm/7"	20,0 cm/8"	18,0 cm/7"	20,0 cm/8"
¼		1 mm	HB 1482-01	HB 1483-01	HB 1488-01	HB 1489-01
		2 mm	HB 1482-02	HB 1483-02	HB 1488-02	HB 1489-02
		3 mm	HB 1482-03	HB 1483-03	HB 1488-03	HB 1489-03
		4 mm	HB 1482-04	HB 1483-04	HB 1488-04	HB 1489-04
		5 mm	HB 1482-05	HB 1483-05	HB 1488-05	HB 1489-05
		6 mm	HB 1482-06	HB 1483-06	HB 1488-06	HB 1489-06

**Bandscheiben-Rongeur**  
**Intervertebral Disc Rongeurs**  
**Pinces à disques vertébrales**  
**Pinzas para discos vertebrales**

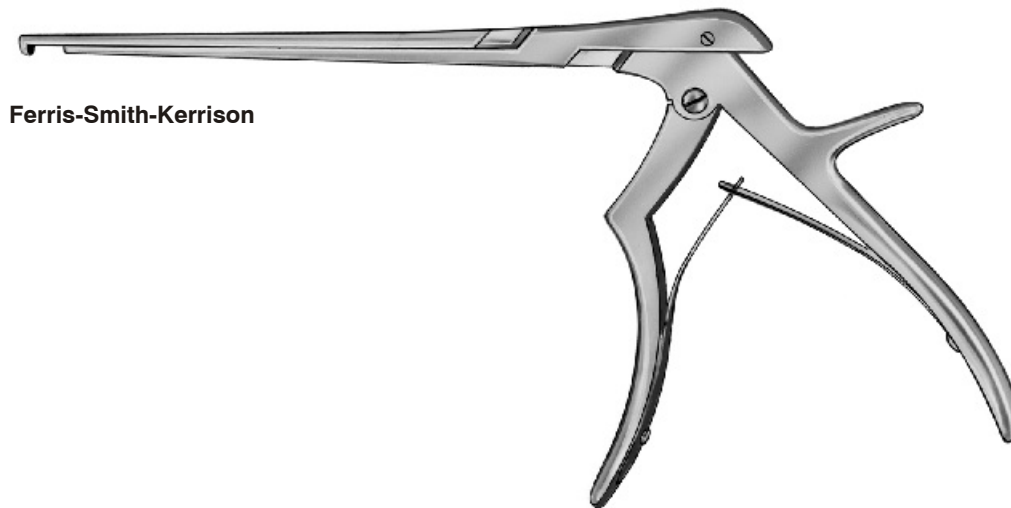

**Ferris-Smith-Kerrison**

		Bißbreite Width of bite Grandeur de coupe Ancho de la boca	Schaftlänge , Length of shaft Longueur de tige, Largo del asta	
			18,0 cm/7"	20,0 cm/8"
¼		1 mm	HB 1484-01	HB 1485-01
		2 mm	HB 1484-02	HB 1485-02
		3 mm	HB 1484-03	HB 1485-03
		4 mm	HB 1484-04	HB 1485-04
		5 mm	HB 1484-05	HB 1485-05
		6 mm	HB 1484-06	HB 1485-06

90° nach unten schneidend  
 90° downwards cutting  
 coupante vers le bas 90°  
 cortante hacia abajo 90°

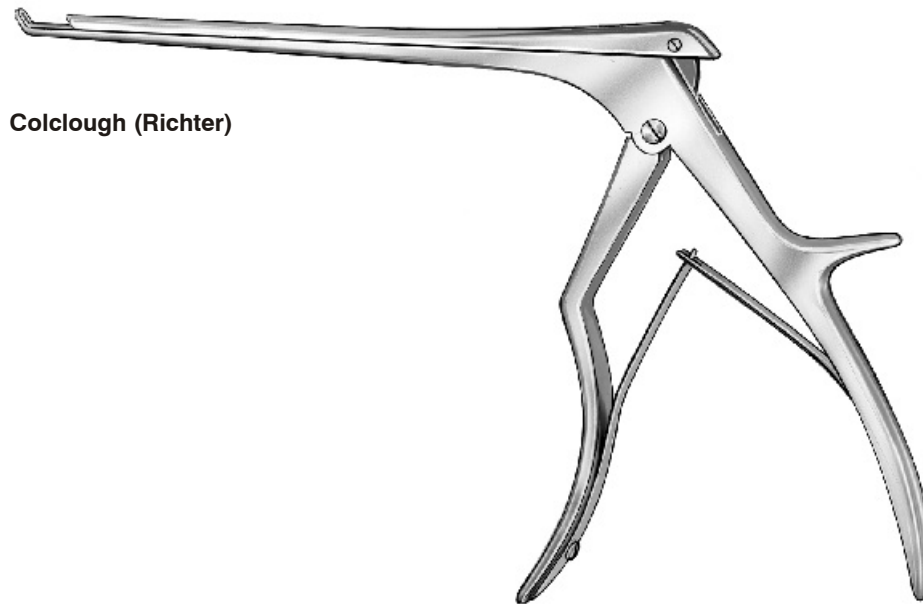

**Bandscheibenstanzen**  
**Intervertebral Disc Rongeurs**  
**Pinces à disques vertébrales**  
**Pinzas cortantes para discos intervertebrales**



Colclough (Richter)

		Bißbreite Width of bite Grandeur de coupe Ancho de la boca	Schaftlänge , Length of shaft Longueur de tige, Largo del asta		
90° nach oben schneidend 90° upwards cutting coupante ver le haut 90° cortante hacia arriba 90°		15,0 cm/6"	18,0 cm/7"	20,0 cm/8"	
¼ □		2 mm	HB 1502-15	HB 1502-18	HB 1502-20
□		3 mm	HB 1503-15	HB 1503-18	HB 1503-20
□		4 mm	HB 1504-15	HB 1504-18	HB 1504-20
□		5 mm	HB 1505-15	HB 1505-18	HB 1505-20
□		6 mm	HB 1506-15	HB 1506-18	HB 1506-20

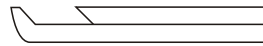
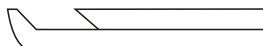
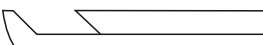
**Colclough (Richter)**

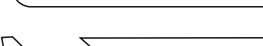
40° nach oben schneidend 40° upwards cutting coupante vers le haut 40° cortante hacia arriba 40°		Bißbreite Width of bite Grandeur de coupe Ancho de la boca	Schaftlänge , Length of shaft Longueur de tige, Largo del asta		
			15,0 cm/6"	18,0 cm/7"	20,0 cm/8"
¼ □		2 mm	HB 1512-15	HB 1512-18	HB 1512-20
□		3 mm	HB 1513-15	HB 1513-18	HB 1513-20
□		4 mm	HB 1514-15	HB 1514-18	HB 1514-20
□		5 mm	HB 1515-15	HB 1515-18	HB 1515-20
□		6 mm	HB 1516-15	HB 1516-18	HB 1516-20

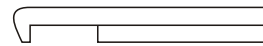
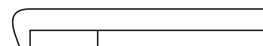
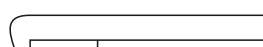
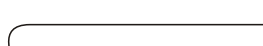
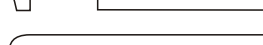
90° nach unten schneidend 90° downwards cutting coupante vers le bas 90° cortante hacia abajo 90°		Bißbreite Width of bite Grandeur de coupe Ancho de la boca	Schaftlänge , Length of shaft Longueur de tige, Largo del asta		
			15,0 cm/6"	18,0 cm/7"	20,0 cm 8"
¼ □		2 mm	HB 1522-15	HB 1522-18	HB 1522-20
□		3 mm	HB 1523-15	HB 1523-18	HB 1523-20
□		4 mm	HB 1524-15	HB 1524-18	HB 1524-20
□		5 mm	HB 1525-15	HB 1525-18	HB 1525-20
□		6 mm	HB 1526-15	HB 1526-18	HB 1526-20

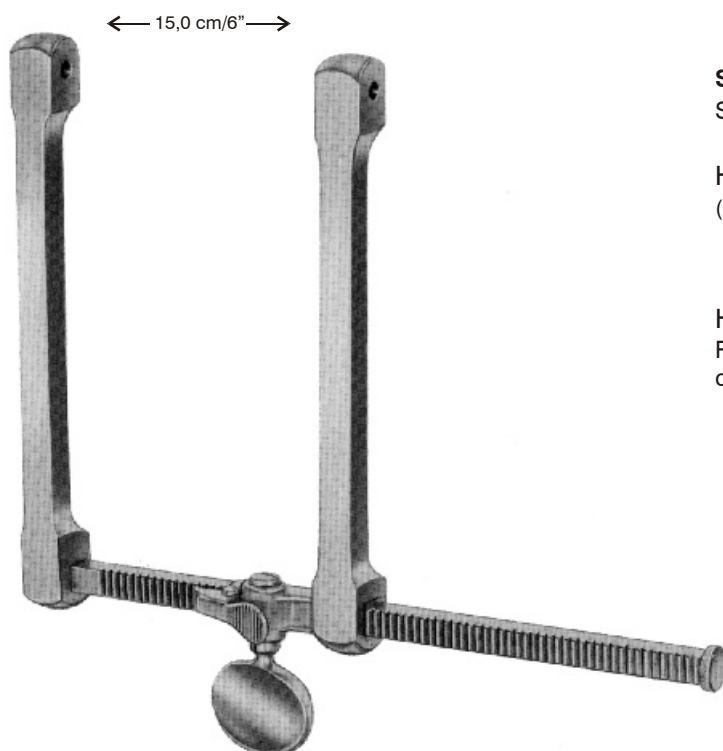

**Scoville**

Set, set, série, juego

HB 1540-00

(1 x HB 1540-01, 1 x HB 1543-50, 1 x HB 1545-01)

HB 1540-01

Rahmen allein, frame only,  
cadre seul, cuadro solo

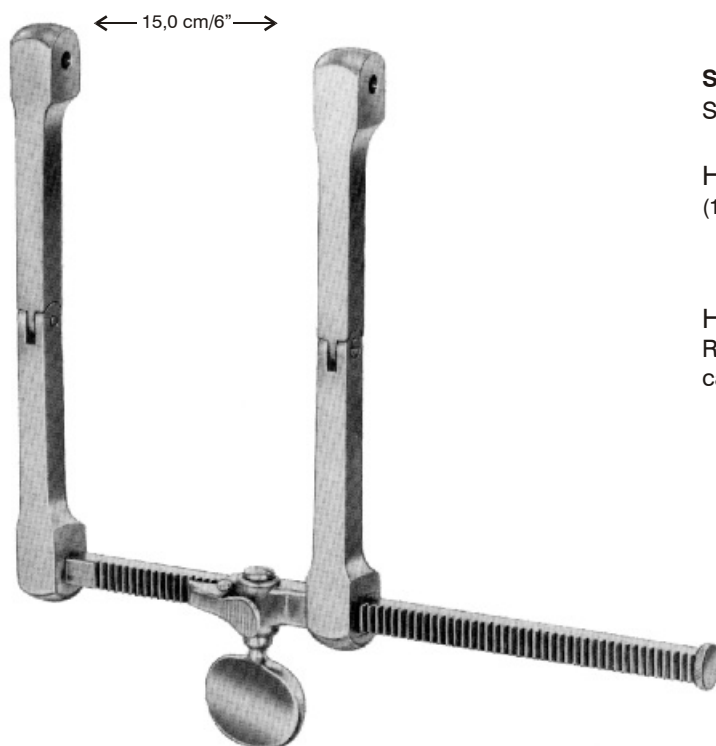

**Scoville-Haverfield**

Set, set, série, juego

HB 1541-00

(1 x HB 1541-01, 1 x HB 1543-50, 1 x HB 1545-01)

HB 1541-01

Rahmen allein, frame only,  
cadre seul, cuadro solo

**Laminectomiespreizer**  
**Laminectomy Spreaders**  
**Ecarteurs pour laminectomie**  
**Separadores para laminectomia**



Haken, Hooks, Crochets, Separadores



**Scoville**  
 stumpf, blunt  
 mousse, romo

HB 1543-50 50 mm/2"  
 HB 1543-70 70 mm/2¾"  
 HB 1543-75 75 mm/3"



**Scoville**  
 spitz, sharp  
 pointu, agudo

HB 1544-50 50 mm/2"  
 HB 1544-70 70 mm/2¾"  
 HB 1544-75 75 mm/3"

Valven, Blades, Valves, Valvas



**Scoville**

HB 1545-01 64 x 25 mm  
 HB 1545-02 64 x 29 mm  
 HB 1545-03 64 x 50 mm  
 HB 1545-04 88 x 25 mm



**Taylor**

HB 1546-01 38 x 44 mm



**Taylor**

HB 1547-01 48 x 50 mm  
 HB 1547-02 64 x 50 mm  
 HB 1547-03 64 x 64 mm  
 HB 1547-04 80 x 57 mm



**Scoville**

HB 1548-01 41 x 38 mm  
 HB 1548-02 67 x 44 mm



**Taylor**

HB 1549-01 32 x 75 mm  
 HB 1549-02 42 x 100 mm



**Meyerding-  
 Scoville**

HB 1550-01 50 x 25 mm  
 HB 1550-02 70 x 25 mm  
 HB 1550-03 83 x 25 mm

gezahnt  
 saw edge  
 dentelée  
 dentada



**Cloward**

HB 1560-01 25,0 cm/9½"  
 Sperrer allein, spreader only  
 ecarteur seule, separador solo

HB 1560-00  
 Set mit 5 gezahnten Valven HB 1561-40 - HB 1561-60  
 Set with 5 toothed blades HB 1561-40 - HB 1561-60  
 Jeu avec 5 valves dentelées HB 1561-40 - HB 1561-60  
 Juego con 5 valvas dentadas HB 1561-40 - HB 1561-60



Valve, gezahnt  
 Blade, saw edge  
 Valve, dentelée  
 Valva, dentada

HB 1561-40 40 mm  
 HB 1561-45 45 mm  
 HB 1561-50 50 mm  
 HB 1561-55 55 mm  
 HB 1561-60 60 mm



**Cloward**

HB 1562-01 17,0 cm/6¾"  
 Sperrer allein, spreader only  
 ecarteur seule, separador solo

HB 1562-00  
 Set mit 5 stumpfen Valven HB 1562-40 - HB 1562-60  
 Set with 5 blunt blades HB 1562-40 - HB 1562-60  
 Jeu avec 5 valves mouses HB 1562-40 - HB 1562-60  
 Juego con 5 valvas romas HB 1562-40 - HB 1562-60



Valve, stumpf  
 Blade, blunt  
 Valve, mousse  
 Valva, roma

HB 1562-40 40 mm  
 HB 1562-45 45 mm  
 HB 1562-50 50 mm  
 HB 1562-55 55 mm  
 HB 1562-60 60 mm

